

SUBCOURSE

SS0131

EDITION

A

US ARMY SIGNAL CENTER AND FORT GORDON

**ANTENNA THEORY
(SC: 25C)**

EDITION DATE: FEBRUARY 2005

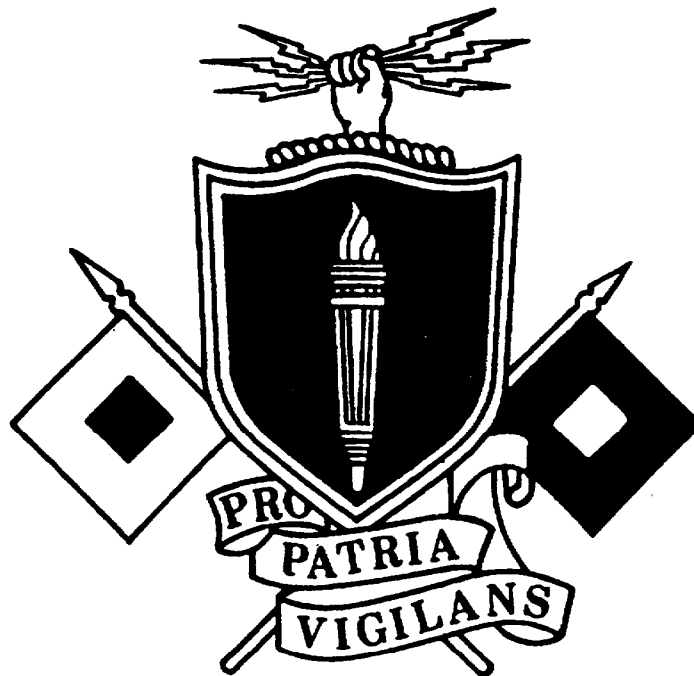

**THE ARMY INSTITUTE FOR PROFESSIONAL DEVELOPMENT
ARMY CORRESPONDENCE COURSE PROGRAM**

**A
I
P
D**

**READINESS /
PROFESSIONALISM**



**THRU
GROWTH**

ANTENNA THEORY

Subcourse Number SS0131

EDITION A

United States Army Signal Center and Fort Gordon
Fort Gordon, Georgia 30905-5000

5 Credit Hours

Edition Date: February 2005

SUBCOURSE OVERVIEW

This subcourse is designed to teach the theory, characteristic, and capabilities of the various types of tactical combat net radio, high frequency, ultra high frequency, very high frequency, and field expedient antennas.

The prerequisites for this subcourse is that you are a graduate of the Signal Office Basic Course or its equivalent.

This subcourse reflects the doctrine which was current at the time it was prepared. In your own work situation, always refer to the latest official publications.

Unless otherwise stated, the masculine gender of singular pronouns is used to refer to both men and women.

TERMINAL LEARNING OBJECTIVE

ACTION: Explain the basic antenna theory and operations of combat net radio, high frequency, ultra high frequency, very high frequency, and field expedient antennas.

CONDITION: Given this subcourse.

STANDARD: To demonstrate competency of this subcourse, you must achieve a minimum of 70 percent on the subcourse examination.

TABLE OF CONTENTS

Section	Page
Subcourse Overview	i
Lesson 1: Antenna Principles and Characteristics	1-1
Practice Exercise	1-14
Answer Key and Feedback	1-16
Lesson 2: Tactical Antennas	2-1
Practice Exercise	2-26
Answer Key and Feedback	2-28
Appendix	A-1

LESSON 1

ANTENNA PRINCIPLES AND CHARACTERISTICS

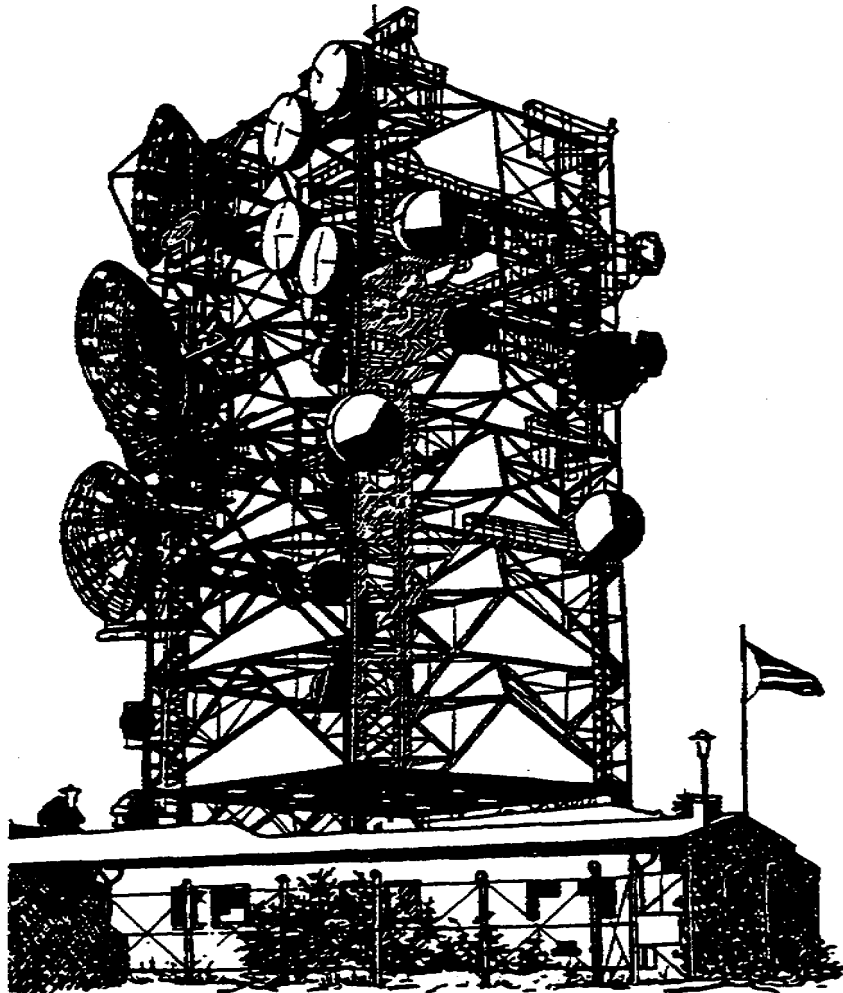

LESSON 1

ANTENNA PRINCIPLES AND CHARACTERISTICS

Critical Tasks: 01-5705.07-0003

01-5879.07-9001

OVERVIEW

LESSON DESCRIPTION:

In this lesson, you will learn about the theory of antennas, to include the principles of antenna radiation, the characteristics of antennas, and the formulas used in antenna design.

TERMINAL LEARNING OBJECTIVE

- ACTION:** Explain basic antenna theory.
- CONDITION** Given this lesson.
- STANDARD:** To demonstrate competence, you must achieve a minimum of 70 percent on the subcourse examination.
- REFERENCES:** The material in this lesson was derived from FM 11-64 and FM 24-18.

INTRODUCTION

An antenna is an integral component of a radio communications system. Signal officers must understand how radio antennas function. Planners and operators should know how signals radiate, what can be done to enhance signal propagation and reception, and how to reduce unwanted interference.

1. General. An antenna is the component of a radio system that is used to send or receive a radio signal. A radio frequency (RF) signal that has been generated in a radio transmitter travels through a transmission line (coaxial cable) to an antenna. An antenna connected to a transmitter is the device that releases RF energy (in the form of an electromagnetic field) to be sent to a distant receiver. The receiving antenna picks up the RF energy. As the electromagnetic field strikes the receiving antenna, a voltage is induced into the antenna, which serves as a conductor. The induced RF voltages are then used to recover the transmitted RF information.

2. Current and voltage distribution.

a. A current flowing in a wire of a length related to the RF produces an electromagnetic field. This field radiates from the wire and is set free in space. The principles of radiation of electromagnetic energy are based on two laws.

(1) A moving electric field creates a magnetic (H) field.

(2) A moving magnetic field creates an electric (E) field.

b. In space, these two fields will be in-phase and perpendicular to each other at any given moment. Although a conductor is usually considered to be present when a moving electric or magnetic field is mentioned, the laws governing these fields do not say anything about a conductor. Thus, these laws hold true whether a conductor is present or not.

c. The current and voltage distribution on a half-wave Hertz antenna is shown in Figure 1-1. In view A, a piece of wire is cut in half and attached to the terminals of a high frequency (HF), alternating current (AC) generator. The frequency of the generator is set so each half of the wire is one-quarter wavelength of the output. The symbol for wavelength is the Greek letter lambda (λ). The result is the common dipole antenna.

d. At a given moment, the generator's right side is positive and its left side is negative. A law of physics states that like charges repel each other. Consequently, electrons will flow away from the negative terminal as far as possible while the positive terminal will attract electrons. View B of Figure 1-1 shows the direction and distribution of electron flow. The distribution curve shows that most current flows in the center and none flows at the ends. The current distribution over the antenna is always the same, regardless of how much or how little current is flowing. However, current at any given point on the antenna will vary directly with the amount of voltage that the generator develops.

e. One-quarter cycle after the electrons begin to flow, the generator develops it; minimum voltage and the current decreases to zero. At that moment, the condition shown in view C of Figure 1-1 will exist. Although no current is flowing, a minimum number of electrons are at the left end of the line and a minimum number are at the right end. The charge distribution along the wire varies as the voltage of the generator varies (view C).

(1) A current flows in the antenna with an amplitude that varies with the generator voltage.

(2) A sine wave distribution of charge exists on the antenna. The charges reverse polarity every half cycle.

(3) The sine wave variation in charge magnitude lags the sine wave variation in current by one-quarter cycle.

3. Radiation of electromagnetic energy. As mentioned earlier, a radio signal is generated by a transmitter, and the RF power is delivered to an antenna. Two fields are set up as the RF power reaches the antenna. One is an induction field associated with the stored energy; the other is a radiation field. The intensities of these fields are large at the antenna, and are proportional to the amount of RF power delivered to the antenna. A radio teletypewriter (RATT) using a high-powered amplitude modulation (AM) radio and a long-wire antenna has stronger fields than a small ANT/PRC-77 frequency modulation (FM) manpacked radio. Only the radiation field remains beyond a short distance from the antenna. This radiation field is made up of an electric component and a magnetic component (electromagnetic radiation). Figure 1-2 shows the components of electromagnetic waves. The electromagnetic field is responsible for the transmission and reception of electromagnetic energy through space. A radio wave is a moving electromagnetic field with components of electric intensity and magnetic intensity arranged at right angles to each other.

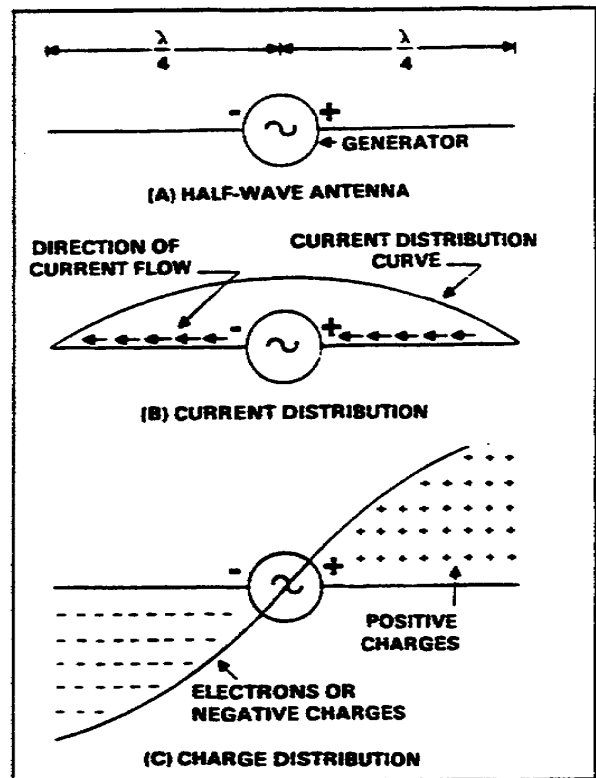

Figure 1-1. Current and voltage distribution on an antenna

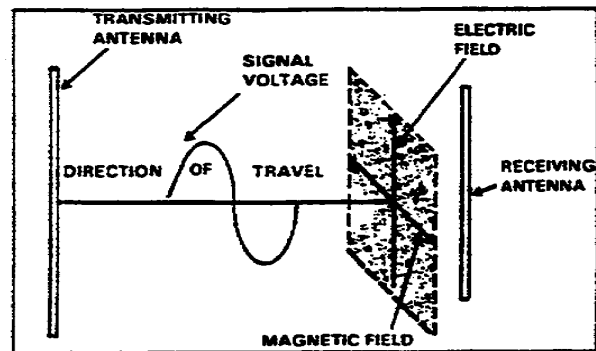

Figure 1-2. Components of electromagnetic waves

4. Antenna characteristics. Output from the transmitter is converted into electromagnetic energy by the antenna and radiated into space. At the receiving antenna, the electromagnetic energy is collected and converted into electrical energy and fed to the receiver.

a. Antenna reciprocity is the ability to use the same antenna for transmitting and receiving. In view A of Figure 1-3, the antenna radiates a minimum amount of energy at right angles to the axis of the antennas. Note the minimum amount of radiation emanating along the axis of the antenna. If the same antenna were used as a receiving antenna (view B), it would receive best in the same directions in which it produced maximum radiation—at right angles to the axis of the antenna.

b. Highly directional antennas transmit and receive more in certain directions than others. Gain is the ratio between the amount of energy transmitted or received in these directions compared to the energy that would be transmitted or received if the antenna were not directional. Antenna gain also gives directional antennas greater transmission range than omnidirectional antennas for an equal signal.

c. A radiated field is composed of electric and magnetic lines of force which are called fields. A radiated wave's polarization is determined by the direction of the electric field in relation to the Earth.

If the lines of electric force are at right angles to the Earth's surface, the wave is vertically polarized (Figure 1-4). If the lines of electric force are parallel to the Earth's surface, the wave is horizontally polarized, as shown in Figure 1-5, page 1-6. When a single-wire antenna is used to extract (receive) energy from a passing radio wave, maximum pickup results when the antenna is oriented so it lies in the same direction as the electric field component. Thus, a vertical antenna is used for efficient reception of vertically polarized waves, and a horizontal antenna is used for horizontally polarized waves. In some cases, the field rotates as the waves travel through space. When this occurs, both the horizontal and vertical components of the field exist, and the wave has elliptical polarization.

d. For ground-wave transmissions, medium and low frequencies are used, and the antennas need to be vertically polarized. This allows the radio wave to travel a considerable distance along the ground surface with minimum absorption by the Earth.

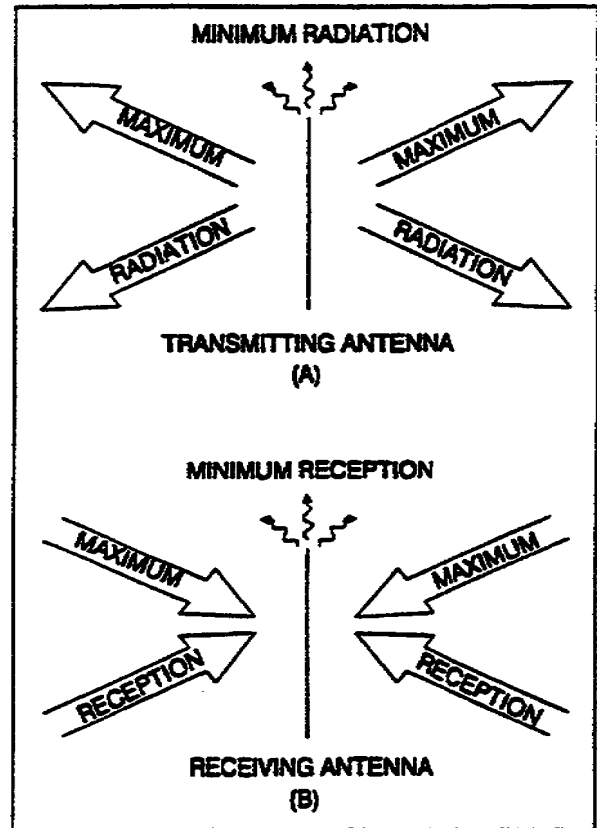

Figure 1-3. Reciprocity of antennas

Horizontal polarization cannot be used at these frequencies because the electric lines run parallel to and touch the Earth. As a horizontal wave travels across the surface, it is attenuated and is not propagated very far. At high frequencies, either horizontal or vertical polarization may be used with sky wave transmission. This is because the sky wave arrives at the receiving antenna elliptically polarized. This polarization is a result of the wave traveling obliquely through the Earth's magnetic field and striking the ionosphere. Thus, the transmitting and receiving antennas can be either horizontal or vertical. When using frequencies in the ultra high frequency (UHF) or very high frequency (VHF) range, either horizontal or vertical polarization is acceptable. But, you must ensure that the transmitting and receiving antennas have the same polarization.

e. An advantage of vertical polarization is that vertical half-wave and quarter-wave antennas can provide omnidirectional communications. This helps when communicating from a moving vehicle, although it radiates equally to both enemy and friendly forces. Another advantage, when using vertical polarization, is that less inference is picked up from strong VHF and UHF broadcast transmissions (television and FM radio). This is because those systems use horizontal polarization.

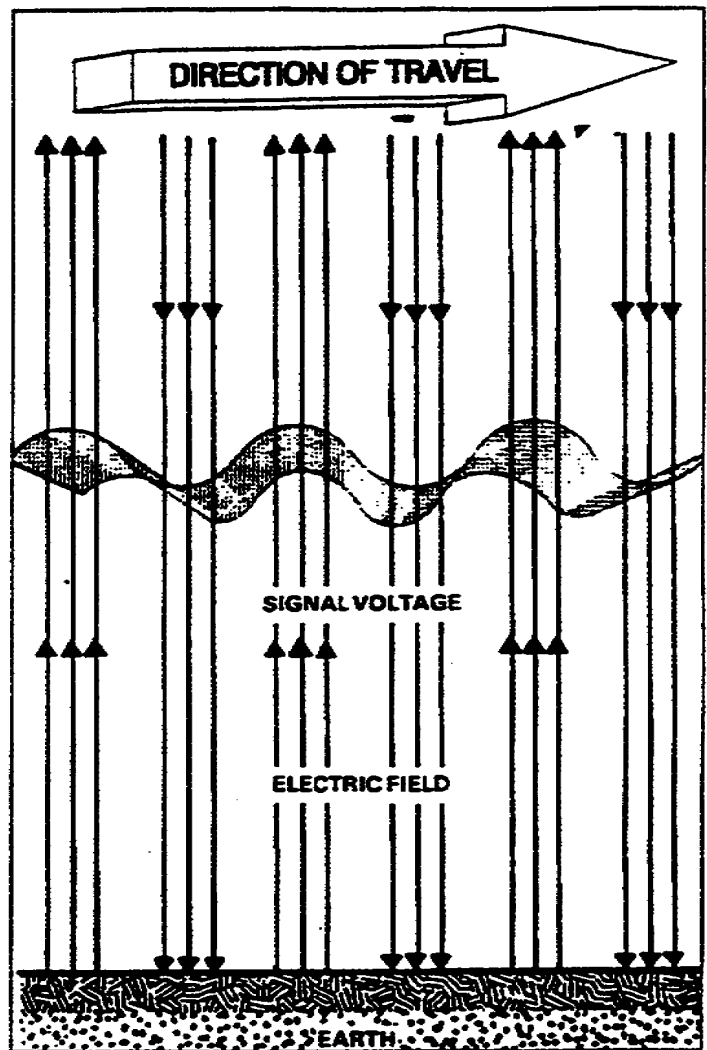

Figure 1-4 Vertically signal

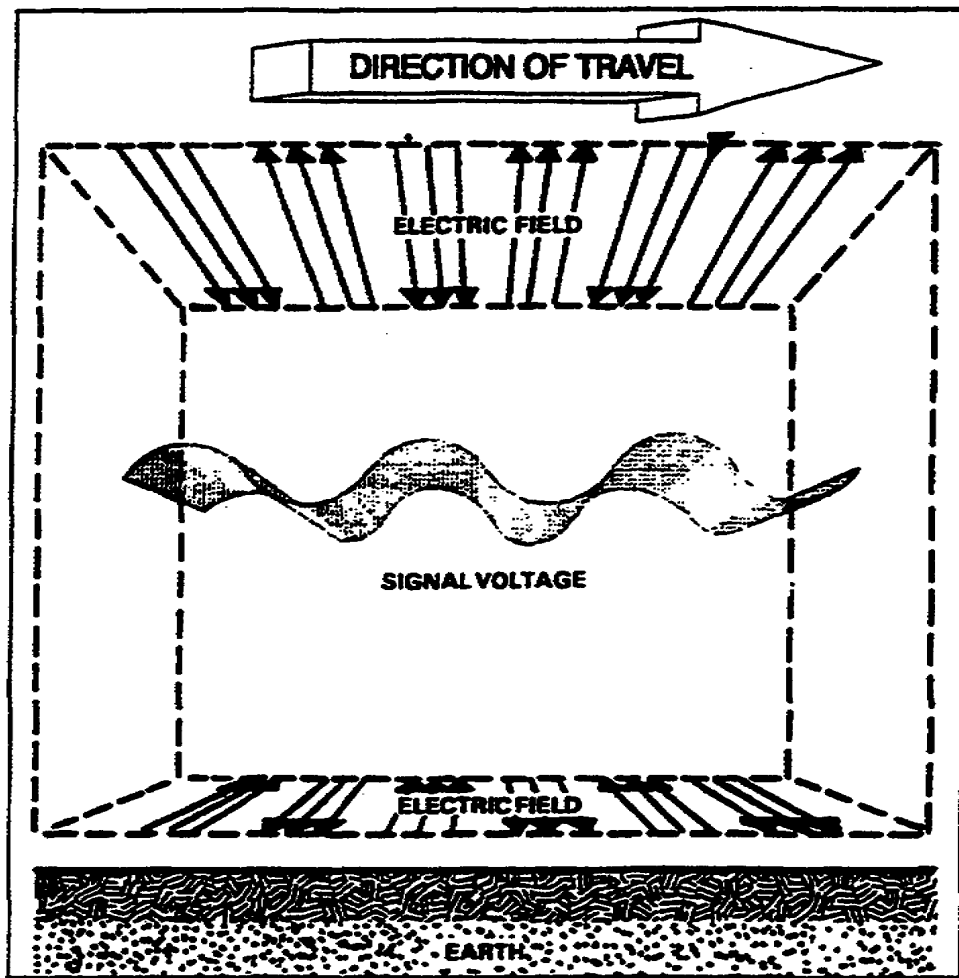

Figure 1-5. Horizontally polarized signal

f. Horizontally polarized antennas do have certain advantages and are preferred at high frequencies. A horizontal antenna is less likely to pick up man-made interference (such as those produced by automobile ignition systems and electrical appliances), which is usually vertically polarized. A second advantage is that there is less absorption of radiated energy by buildings or wiring when a horizontal antenna is used. In addition, a simple horizontal half-wave antenna is bi-directional which is useful in minimizing interference from certain directions. Finally, horizontally polarized waves suffer lower losses than vertically polarized waves, especially above 100 MHz. Antennas located near dense rests should be horizontally polarized.

g. Directionality is the characteristic of an antenna that allows it to transmit and receive in a specific direction. Other stations operating on the same or nearby frequencies may interfere with the desired signal and make reception difficult or impossible. Reception of a desired signal can be improved by using directional antennas. Horizontal half-wave antennas accept radio signals from all directions, with the strongest reception being received in a line perpendicular to the antenna (broadside), and the weakest reception being received from the direction of the antenna's ends. Changing the antenna's

axis so either end points directly toward the interfering source may eliminate or reduce interference. Directional transmitting antennas concentrate radiation in a given direction and minimize radiation in other directions. A directional antenna may be used to lessen enemy interception and interference with friendly stations.

h. Since antennas are erected over the Earth and not out in free space, except for those on satellites, the ground's presence alters the free space radiation patterns of antennas. The ground also affects some of the electrical characteristics of an antenna. It has the greatest effect on those antennas that must be mounted relatively close to the ground, in terms of wavelength. For example, medium and high frequency antennas, elevated above the ground by only a fraction of a wavelength, will have radiation patterns that are quite different from the free-space patterns.

i. Grounded antenna theory. The ground, a good conductor for medium and low frequencies, acts as a large mirror for the radiated energy. This results in the ground reflecting a large amount of energy that is radiated downward from an antenna mounted over it. Using this characteristic of the ground, an antenna only a quarter-wavelength long can be made into the equivalent of a half-wave antenna. A quarter-wave antenna erected vertically, with its lower end connected electrically to the ground, as shown in Figure 1-6, behaves like a half-wave antenna. Under these conditions, the ground takes the place of the missing quarter-wavelength, and the reflections supply that part of the radiated energy that normally would be supplied by the lower half of an ungrounded half-wave antenna.

j. There are several types of grounds.

(1) When grounded antennas are used, the ground must have as high a conductivity as possible. This reduces ground losses and provides the best possible reflecting surface for the down-going radiated energy from the antenna. At low and medium frequencies, the ground acts as a sufficiently good conductor. Thus, the ground connection must be made in such a way as to introduce the least possible amount of resistance to ground. At higher frequencies, artificial grounds constructed of large metal surfaces are common.

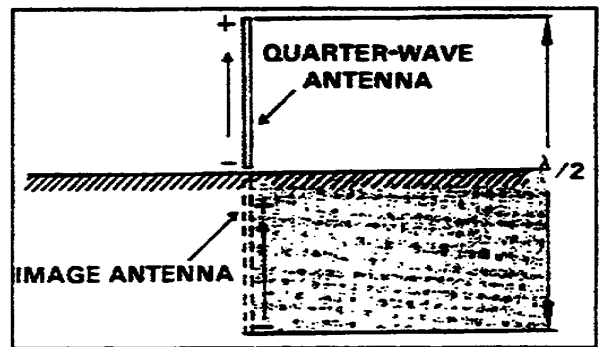

Figure 1-6. Quarter-wave antenna connected to ground

(2) The ground connections take many forms, depending on the type of installation and the loss that can be tolerated. In many simple field installations, the ground connection is made by driving one or more metal rods into the soil. When more satisfactory arrangements cannot be made, ground leads can be connected to existing devices that are grounded. Metal structures or underground pipe systems are commonly

used as ground connections. In an emergency, a ground connection can be made by forcing one or more bayonets into the soil.

(3) When an antenna must be erected over soil with low conductivity, treat the soil with substances that are highly conductive, when in solution, to reduce the soil's resistance. Some of these substances, listed in order of preference, are sodium chloride (common salt), calcium chloride, copper sulphate (blue vitriol), magnesium sulphate (Epsom salt), and potassium nitrate (saltpeter). The amount required depends on the type of soil and its moisture content. Please note that when these substances are used, they must not get into nearby drinking water supplies.

(4) For simple installations, a single ground rod can be fabricated in the field from pipe or conduit. A low resistance connection must be made between the ground wire and the ground rod. The rod should be cleaned thoroughly by scraping and sandpapering at the point where the connection is to be made, and a clean ground clamp should be installed. A ground wire can then be soldered or joined to the clamp. This joint should be covered with tape to prevent an increase in resistance due to oxidation.

k. When an actual ground connection cannot be used because of the high resistance of the soil or because a large buried ground system is not practical, a counterpoise can be used to replace the usual direct ground connection.

(1) A counterpoise consists of a device made of wire that is erected a short distance above the ground and insulated from it. The counterpoise's size should be at least equal to or larger than the size of the antenna.

(2) When the antenna is mounted vertically, the counterpoise should be made into a simple geometric pattern; perfect symmetry is not required. The counterpoise acts as an artificial ground that helps to produce the required radiation pattern. Figure 1-7 shows an RC-292 ground-plane antenna. The three antenna elements pointing downward provide the counterpoise for this antenna.

(3) In some VHF antenna installations on vehicles, the metal roof of the vehicle or shelter is used as a counterpoise for the antenna. Small counterpoises of metal mesh are sometimes used with special VHF antennas that must be located a considerable distance above the ground.

s

1. Depending on the type of antenna used, radio energy radiated by an antenna forms an electromagnetic field that has a definite pattern. A radiation pattern shows the directional characteristics of an antenna. A vertical antenna (Figure 1-7) or a whip antenna on a vehicle radiates energy equally in all directions (omnidirectionally). A horizontal antenna, like those used with RATT systems, is bidirectional. Unidirectional antennas radiate energy in only one direction. These radiation patterns do not provide perfectly symmetrical coverage. There are distortions in the patterns (back lobes and side lobes) which are attributed to the antenna's physical characteristics and nearby obstructions or terrain features. Three common radiation patterns are shown in Figure 1-8, page 1-10. The upper pattern is that of a quarter-wave vertical antenna. Note its omnidirectional pattern. The center pattern shows a half-wave horizontal pattern, located one-half wavelength above the ground. RATT rigs use these long-wire or doublet antennas. The bottom pattern is that of a vertical half-rhombic antenna that radiates in one direction.

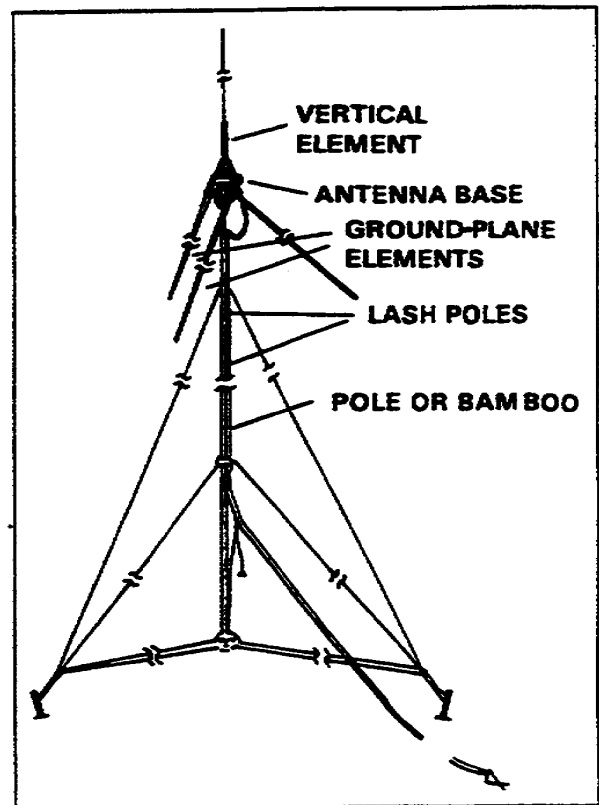

Figure 1-7. RC-292 ground-plane antenna

m. An antenna's length is related to the wavelength of the frequency used. An antenna has both a physical length and an electrical length, and the two are never the same. Use the following formulas to calculate the physical length of a half-wave long-wire antenna.

$$\text{Length of a half-wave antenna (in feet)} = \frac{468}{\text{frequency (in MHz)}}$$

$$\text{Length of a half-wave antenna (in meters)} = \frac{142.6}{\text{frequency (in MHz)}}$$

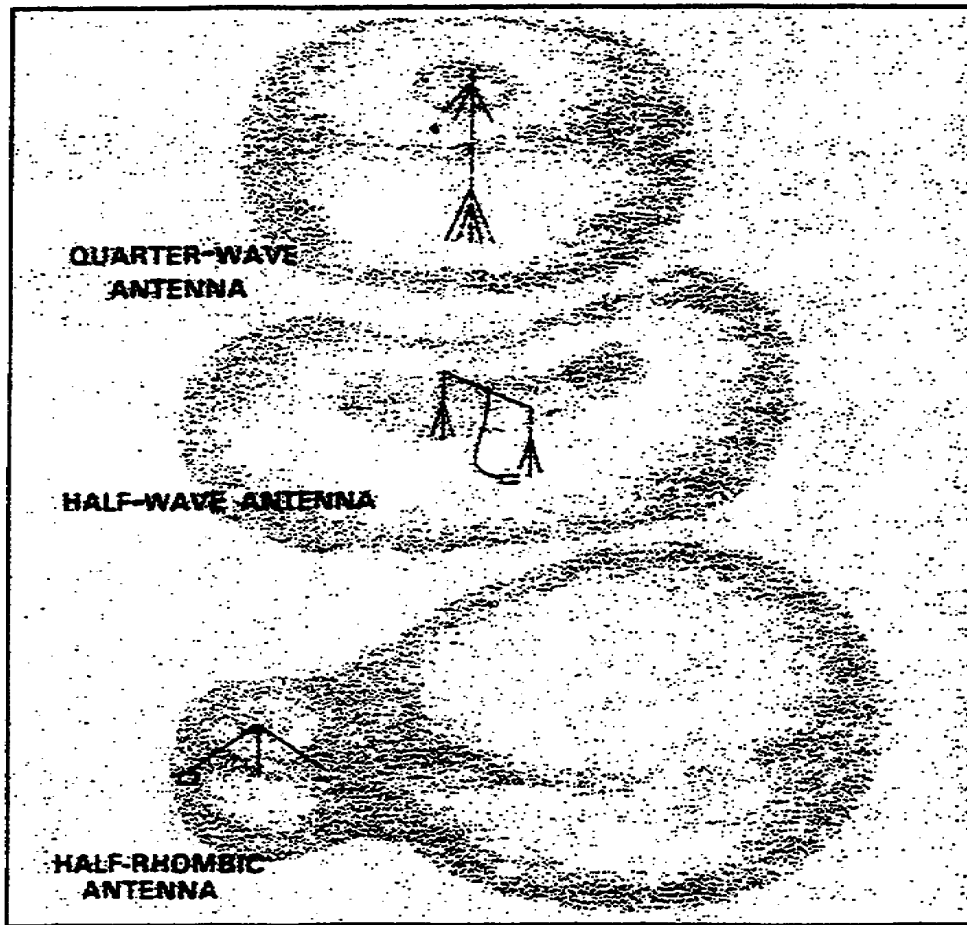

Figure 1-8. Radiation patterns from quarter-wave, half-wave, and vertical half-rhombic antennas.

As an example, a radio operator must design a long-wire (doublet) antenna for use with an AM radio, tuned to 12 MHz. Using the formula:

$$\text{Length of a half-wave antenna (in feet)} = \frac{468}{12 \text{ (MHz)}} = 39 \text{ feet}$$

The operator must measure the antenna 39 feet in length to operate at a frequency of 12 MHz. The AN/GRA-50 antenna group is the most common antenna assembly used to erect a long-wire antenna. Figure 1-9 shows the AN/GRA-50's component parts. A very useful component is the tape measure, which is graduated in both feet and meters. An operator lays out the antenna wire and measures the required length. The electrical length of an antenna must be compatible with the frequency used. When you change the frequency on the radio, the antenna matching unit mounted on the vehicle will automatically change the electrical length of the whip antenna.

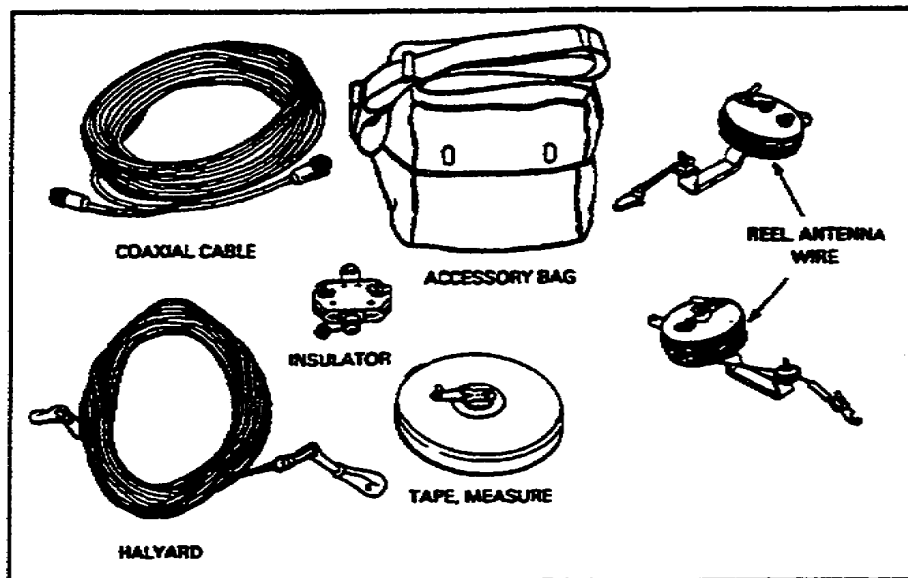

Figure 1-9. AN/GRA-50 antenna group

5. Summary. In this lesson, you learned about the theory of antennas, including the principles of antenna radiation, the characteristics of antennas, and the formulas used in antenna design.

- a. Current flows in the antenna with an amplitude that varies with the generator voltage.
- b. Two fields are established at an antenna (the induction field and the radiation field). The radiation field is made up of an electric component and a magnetic component (electromagnetic).
- c. Output from a transmitter is released at the antenna in the form of electromagnetic energy. At the receiving antenna, electromagnetic energy is collected and converted into electrical energy, where it is fed to the radio receiver.
- d. Antenna reciprocity is the feature that allows an antenna to both transmit and receive radio signals.
- e. Antenna gain is the ratio between the amount of energy propagated in certain directions, compared to the energy that would be propagated if the antenna were not directional. Antenna gain also gives directional antennas greater transmission range than omnidirectional antennas for an equal signal.
- f. The orientation of a radio wave's electric field in relation to the Earth is known as its polarization. A radiated wave can be vertically, horizontally, or elliptically polarized.
- g. Directionality is the characteristic of an antenna that allows it to transmit and receive in a specific direction.

h. The earth (ground) can be used as a conductor for radio frequencies.

i. A counterpoise is a conductor or system of conductors used as a substitute for a ground in an antenna system.

j. Radiation patterns can be omnidirectional (all directions), bidirectional (two directions), or unidirectional (one direction).

k. To calculate the physical length of a half-wave long-wire antenna, use the following formulas:

$$\text{Length of a half-wave antenna (in feet)} = \frac{468}{\text{frequency (in MHz)}}$$

$$\text{Length of a half-wave antenna (in meters)} = \frac{142.6}{\text{frequency (in MHz)}}$$

THIS PAGE INTENTIONALLY LEFT BLANK

LESSON 1

PRACTICE EXERCISE

The following items will test your grasp of the material covered in this lesson. There is only one correct answer for each item. When you complete the exercise, check your answers with the answer key that follows. If you answer any item incorrectly, study again that part of the lesson which contains the portion involved.

1. Which statement describes antenna theory?
 - A. A moving electric field creates an electric field
 - B. A moving magnetic field creates a magnetic field
 - C. An antenna is not a radio system component
 - D. Current at any given point on the antenna will vary depending on the voltage

2. A current flows in an antenna with _____ that varies with the applied voltage.
 - A. A frequency
 - B. A wavelength
 - C. An amplitude
 - D. A polarization

3. The amount of energy propagated by an antenna in a certain direction, compared to the energy propagated by that antenna if it were not directional, is called what?
 - A. Reciprocity
 - B. Polarization
 - C. Ground effect
 - D. Gain

4. A quarter-wave antenna erected vertically, with its lower half connected to the ground, operates like what?
 - A. A directional antenna
 - B. A vertical antenna
 - C. A horizontal antenna
 - D. A half-wave antenna

5. Treating soil with salt will enhance what?
 - A. Its resistance
 - B. Its conductivity
 - C. Its moisture content
 - D. Its density

6. A counterpoise does which of the following?
- A. Provides an artificial ground that helps to produce the required radiation pattern
 - B. Increases the transmitting range of the antenna
 - C. Increases signal attenuation
 - D. Ensures antenna reciprocity
7. Which radiation pattern does a whip antenna normally have?
- A. Unidirectional
 - B. Bi-directional
 - C. Omnidirectional
 - D. Elliptical
8. A signal team must construct a half-wave long-wire antenna for use with its AM radio, operating at a frequency of 10 MHz. How long must the antenna be?
- A. 4.68 meters
 - B. 4.68 feet
 - C. 46.8 meters
 - D. 46.8 feet
9. What is the orientation of a radio wave's electric field in relation to the Earth?
- A. Gain
 - B. Reciprocity
 - C. Polarization
 - D. Directionality

LESSON 1

PRACTICE EXERCISE

ANSWER KEY AND FEEDBACK

<u>Item</u>	<u>Correct Answer and Feedback</u>
1.	D. Current at any given point on the antenna will vary depending on the voltage (page 1-2, para 2d)
2.	C. An amplitude (page 1-3, para 2e(1))
3.	D. Gain (page 1-4, para 4b)
4.	D. A half-wave antenna (page 1-7, para 4i)
5.	B. Its conductivity (page 1-8, para 4j(3))
6.	A. Provides an artificial ground that helps to produce the required radiation pattern (page 1-8, para 4k(2))
7.	C. Omnidirectional (page 1-9, para 4l)
8.	D. 46.8 feet (page 1-9, para 4m) Length of a half-wave antenna (in feet) = $\frac{468}{\text{frequency (in MHz)}}$
9.	C. Polarization (page 1-4, para 4c)

THIS PAGE INTENTIONALLY LEFT BLANK

LESSON 2

TACTICAL ANTENNAS

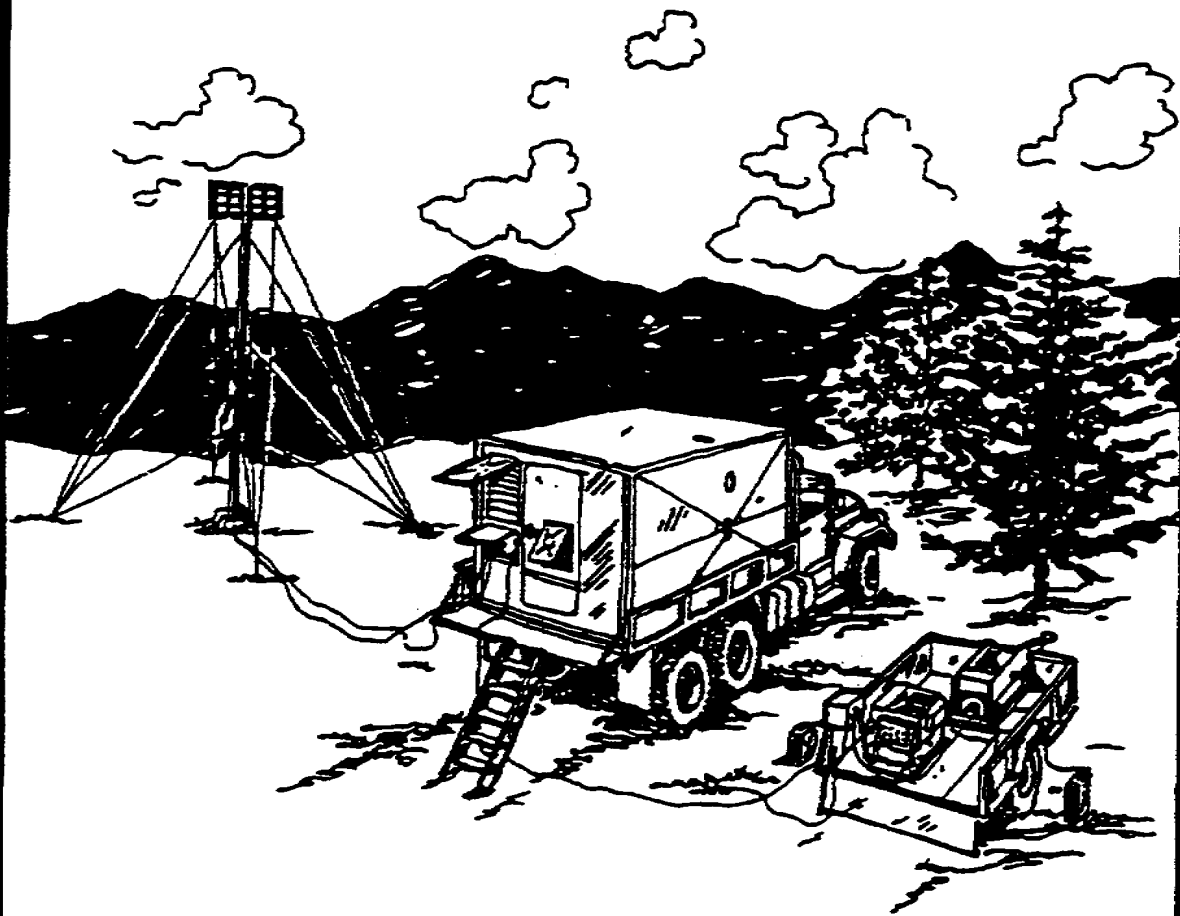

LESSON 2

TACTICAL ANTENNAS

Critical Tasks: 01-5705.07-0003
01-5879.07.9001

OVERVIEW

LESSON DESCRIPTION:

In this lesson, you will learn about the types of tactical antennas and their radiation patterns. In addition, you will learn about fabricating field expedient antennas using various repair techniques.

TERMINAL LEARNING OBJECTIVE:

- ACTION:** Explain basic antenna theory.
- CONDITION:** Given this lesson.
- STANDARD:** To demonstrate competence, you must achieve a minimum of 70 percent on the subcourse examination.
- REFERENCES:** The material in this lesson was derived from FM 11-32, FM 11-64, FM 24-18, FM 24-19, and TC 24-24.

INTRODUCTION

Tactical antennas are designed for efficiency and ease-of-use, and are ruggedized to take the abuse they receive in the field. Some antennas are easy to use, such as a whip antenna that is used in high mobility operations. Others, like directional antennas, require a working knowledge of antenna engineering. All antennas either release or capture electromagnetic radiation.

1. General. Most practical transmitting antennas are divided into two basic classifications-half-wave antennas and quarter-wave antennas. An antenna operates some distance above the ground and may be polarized either vertically or horizontally. A quarter-wave antenna operates with one end grounded. Quarter-wave antennas are used both below and above 2 MHz. Half-wave antennas are used at the higher frequencies (above 2 MHz).

2. Half-wave antenna. The half-wave antenna operates on the principle that the wavelength to which any wire will electrically tune depends upon its physical length. It is center-fed. Its total wire length equals a half of the wavelength of the signal to be transmitted. The maximum radiation emanates perpendicular from the axis to the half-wave antenna. The half-wave antenna is also known as a doublet, a dipole, or a Hertz antenna. It can be erected in a vertical, horizontal, or slanting position between trees or with upright supports from a kit. The half-wave antenna is used for voice or RATT messages when the tactical situation permit stationary operation. It is used for operating in the 2-to 30-MHz frequency range, and it extends the signal range to 300 miles and beyond by using sky wave propagation. The half-wave antenna operates at high frequencies when used on an aircraft or vehicle. In such cases the aircraft or vehicle chassis becomes the effective ground for the antenna. The AN/GRA-50 antenna group that is used in erecting a half-wave system is shown in Figure 2-1. Two configurations for the AN/GRA-50 half-wave antenna are shown in Figures 2-2 and 2-3, pages 2-3 and 2-4.

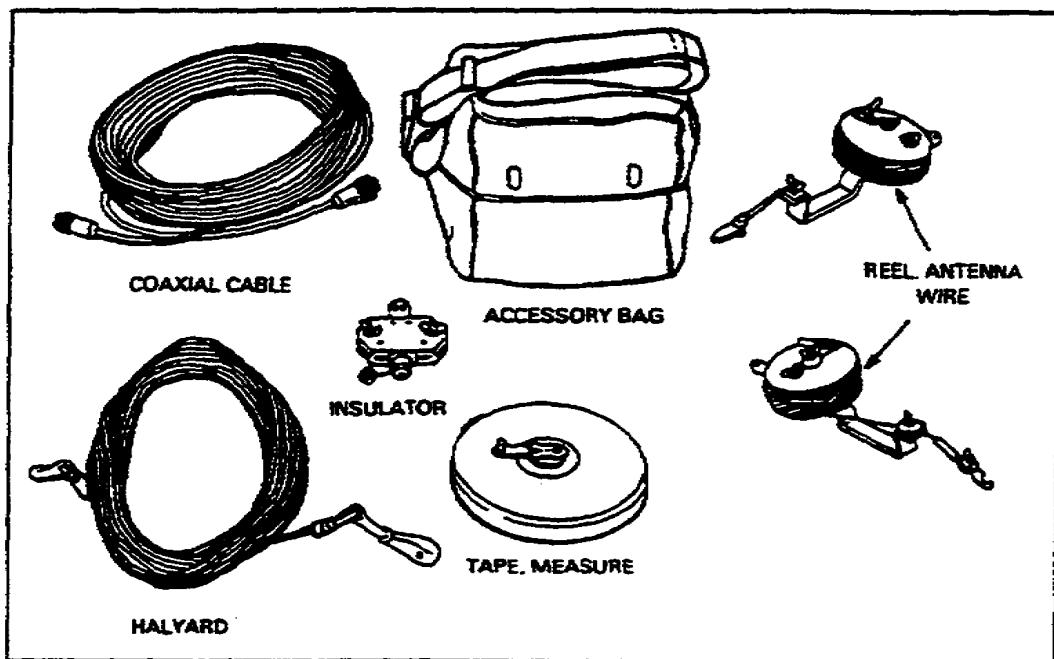

Figure 2-1. AN/GRA-50 antenna group

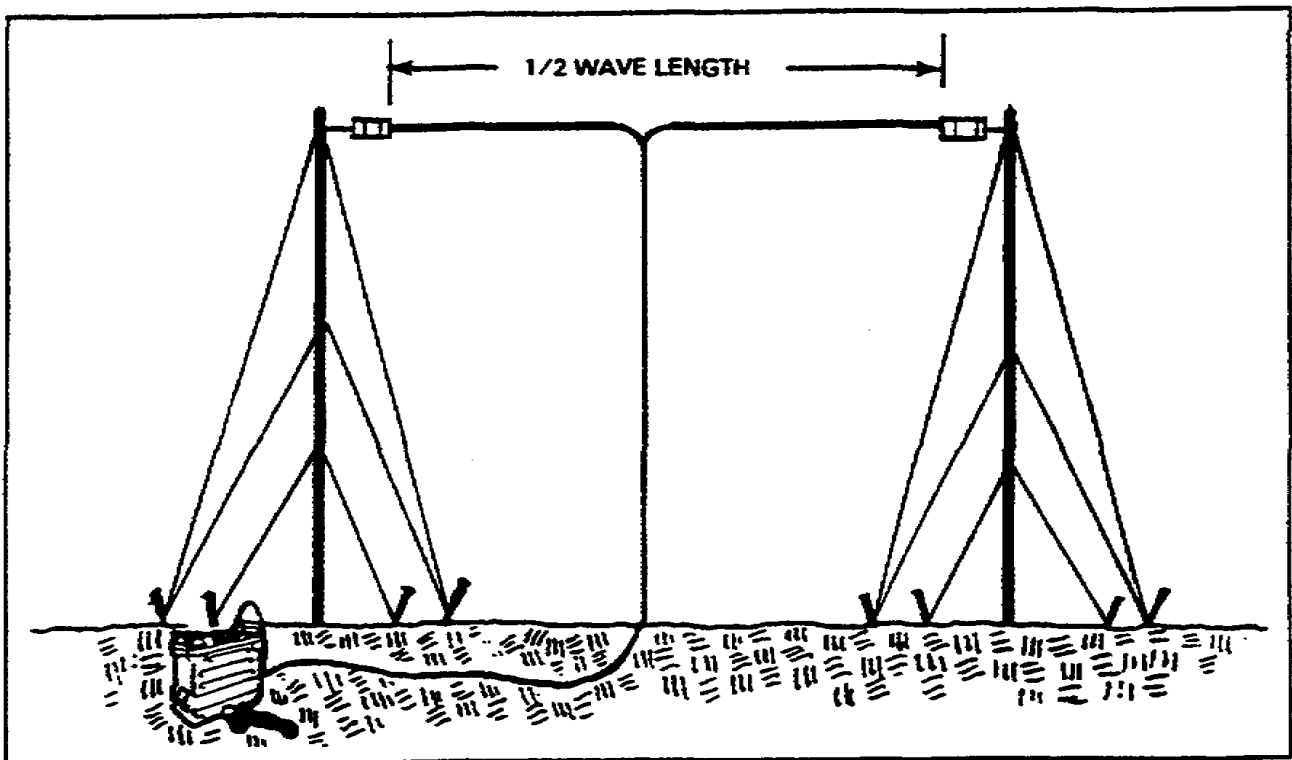

Figure 2-2. Half-wave doublet antenna with two upright supports

3. Whip antenna. The efficient half-wave antenna is not practical for use in mobile operations, particularly with vehicular-mounted radio set. The whip is the most common antenna used for both manpack and mobile vehicle operations. It is electrically short and vertically positioned. To achieve an efficiency comparable to that of a half-wave antenna, the height of the vertical radiator should be a quarter wavelength. To attain this, a loaded whip is used. This loading increases the electrical length of the vertical radiator to a quarter wavelength. The other quarter wavelength of the antenna is supplied by the ground, a counterpoise, or any conducting surface that is large enough. Some common whip antenna applications are shown in Figure 2-4, page 2-5.

a. Whip antennas used with HF tactical radio sets can be as long as 15 feet, such as the whip used on a RATT rig. The whip antenna provides an omnidirectional pattern during mobile operations. When the RATT rig arrives at its destination, its crew switches to the half-wave antenna.

b. The whip antenna used with lightweight portable FM radios is 3 ft long for the semi-rigid steel tape antenna and 10 ft long for the multisection whip antenna. It is shorter than a quarter wavelength to keep it at a practical length. (A quarter wavelength antenna for 5 MHz would be over 46 feet long.) An antenna tuning unit, built into the radio set or supplied with it, compensates for the missing antenna length. The tuning unit (called a matching unit when mounted on the antenna) varies the electrical length of the antenna to accommodate a range of frequencies.

c. The whip antennas used with tactical radio sets radiate an omnidirectional pattern in the horizontal plane. This radiation pattern is ideal for tactical operations because the stations in a radio net will lie in random directions and will frequently change their positions.

d. When a whip antenna is mounted on a vehicle, the metal of the vehicle affects antenna's operation. As a result, the direction in which the vehicle is facing may affect transmission and reception, particularly of distant or weak signals. A vehicle with a whip antenna mounted on the left rear side transmits its strongest signal in a line running from the antenna through the right front side of the vehicle. Likewise, an antenna mounted on the right rear side of the vehicle transmits its strongest signal in a direction toward the left front side. The best reception is obtained from signals traveling in the direction shown by the dashed arrows in Figure 2-5, page 2-6.

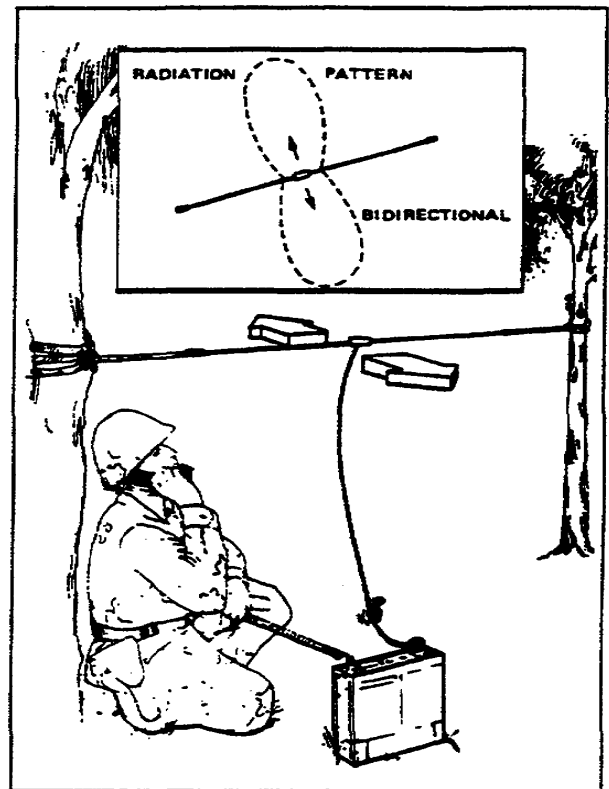

Figure 2-3. Half-wave doublet antenna supported by trees

e. The best direction for transmission can often be determined by driving the vehicle in a small circle until the best position is located. Normally, the best reception and transmission are achieved in the same direction.

4. Ground-plane antenna. This antenna is a vertical quarter-wave antenna that is used to increase the transmission and reception range of tactical FM radio sets. It uses radial elements (acting as a counterpoise) that serve as the ground. The coaxial cable is connected with the inner conductor feeding the vertical element, and the braid of the coaxial cable is connected to the radials (the ground-plane) to keep them at ground potential. The ground-plane antenna is a broad-tuned type that radiates efficiently over a wide range of frequencies. The two tactical ground-plane antennas in wide use throughout the US Army are the RC-292 and the OE-254.

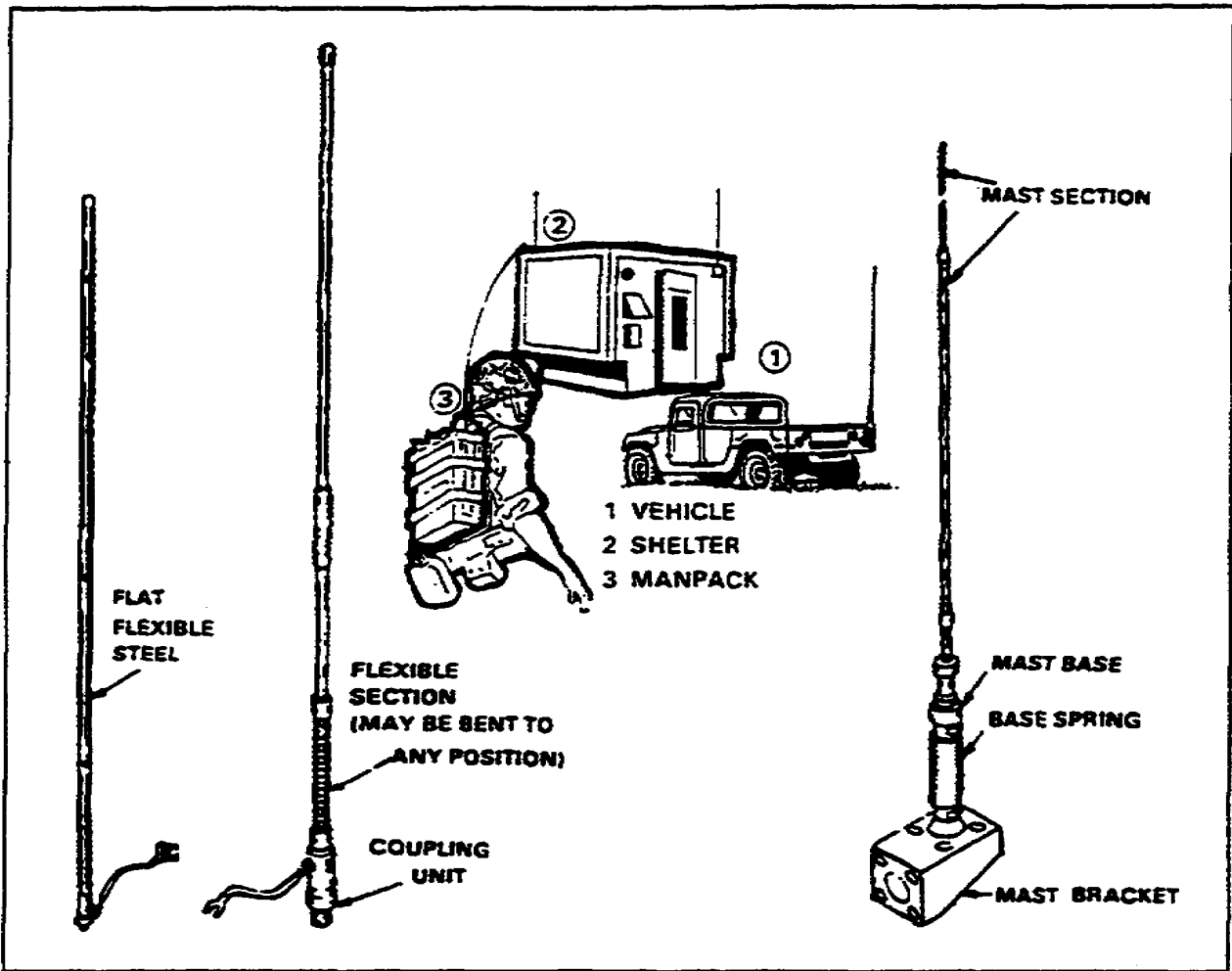

Figure 2-4. Whip antennas

a. The RC-292 is a stationary, general-purpose, ground-plane antenna. The vertical radiating element and the ground-plane elements must be changed to the proper length for different operating frequencies. Its frequency range is between 20 and 76 MHz, and its planning range is about twice that of a radio set using a quarter-wave whip antenna. The RC-292 antenna can be erected at various heights up to 41 feet, depending on the number of mast sections used. Figure 2-6, page 2-7, shows an erected RC-292 antenna.

b. The OE-254 broadband, omnidirectional VHF antenna system is replacing the RC-292. The OE-254 antenna operates in the 30-to 88-MHz frequency range without the need to manually drop and change out antenna elements. Its planning range is about 36 miles for average terrain. Like the RC-292, the OE-254 can be erected at different heights, depending on the number of mast section used. An erected OE-254 is depicted in Figure 2-7, page 2-7.

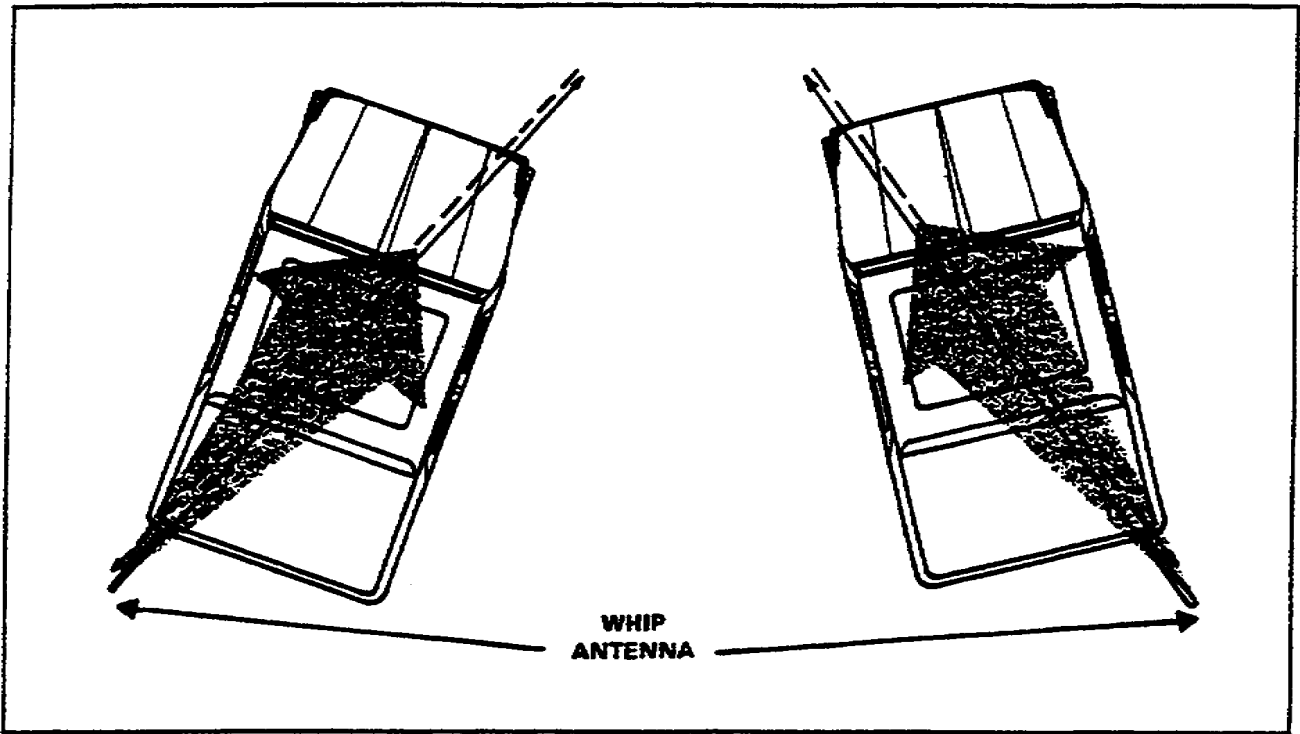

Figure 2-5. Best directivity of whip antenna mounted on vehicle

5. Directional VHF log-periodic antenna.

a. This broadband, omnidirectional antenna provides an extended range and directivity for tactical radios. It is used to communicate in the 30-to 88-MHz frequency range and does not require any mechanical or electrical adjustments.

b. The log-periodic antenna can operate with either horizontal or vertical polarization. It has the capability of changing polarization in less than one minute.

c. The highly directional radiation pattern of the log-periodic antenna provides very effective electronic counter-countermeasures (ECCM) in a hostile electronic warfare (EW) environment. Since its radiated energy is focused in one direction, less transmitter power is needed, further enhancing ECCM.

d. This antenna can be erected in a geographical area no greater than 60 feet in diameter by two soldiers in 20 minutes. Its mechanical azimuth can be changed within one minute. This antenna can be mounted on a quick-erect mast either on a vehicle or a shelter, and transported by manpack or tactical vehicle when fitted into two packages (one for the antenna and one for the mast).

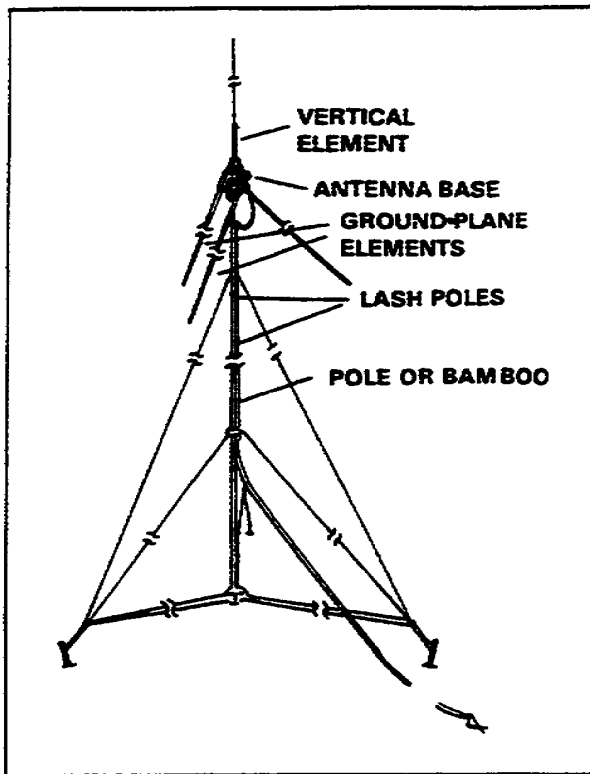

Figure 2-6. RC-292 ground-plane antenna

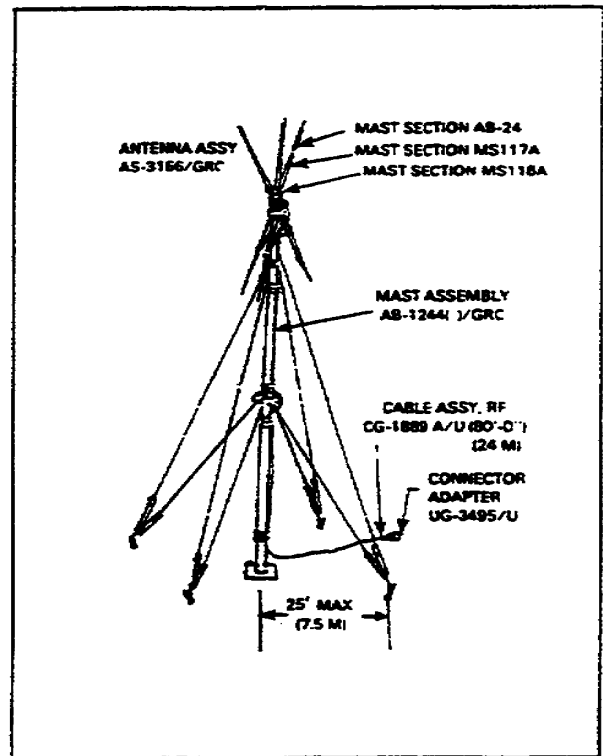

Figure 2-7. OE-254 ground-plane antenna

e. The log-periodic antenna is organic to battalion and higher level units for special applications. It is primarily used by forward units in command and intelligence nets to a higher headquarters. Because it is a directional antenna, its use is usually restricted to point-to-point communications.

f. Figure 2-8, page 2-8, illustrates the log-periodic antenna in three configurations.

6. VHF half-rhombic antenna OE-303.

a. The half-rhombic antenna is used mostly for special purposes by forward units over extended distances on command and control and intelligence nets. The OE-303 antenna is a vertically polarized antenna which, when used with the current VHF-FM tactical radios, considerably extends the transmission range. It provides some degree of ECCM protection not offered by the current VHF-FM omnidirectional antenna. When properly employed, the half-rhombic antenna decreases VHF-FM radio susceptibility to hostile EW operations and enhances the communications ranges of the deployed radio set. This effect is realized by directing the maximum signal strength in the direction of the desired friendly unit.

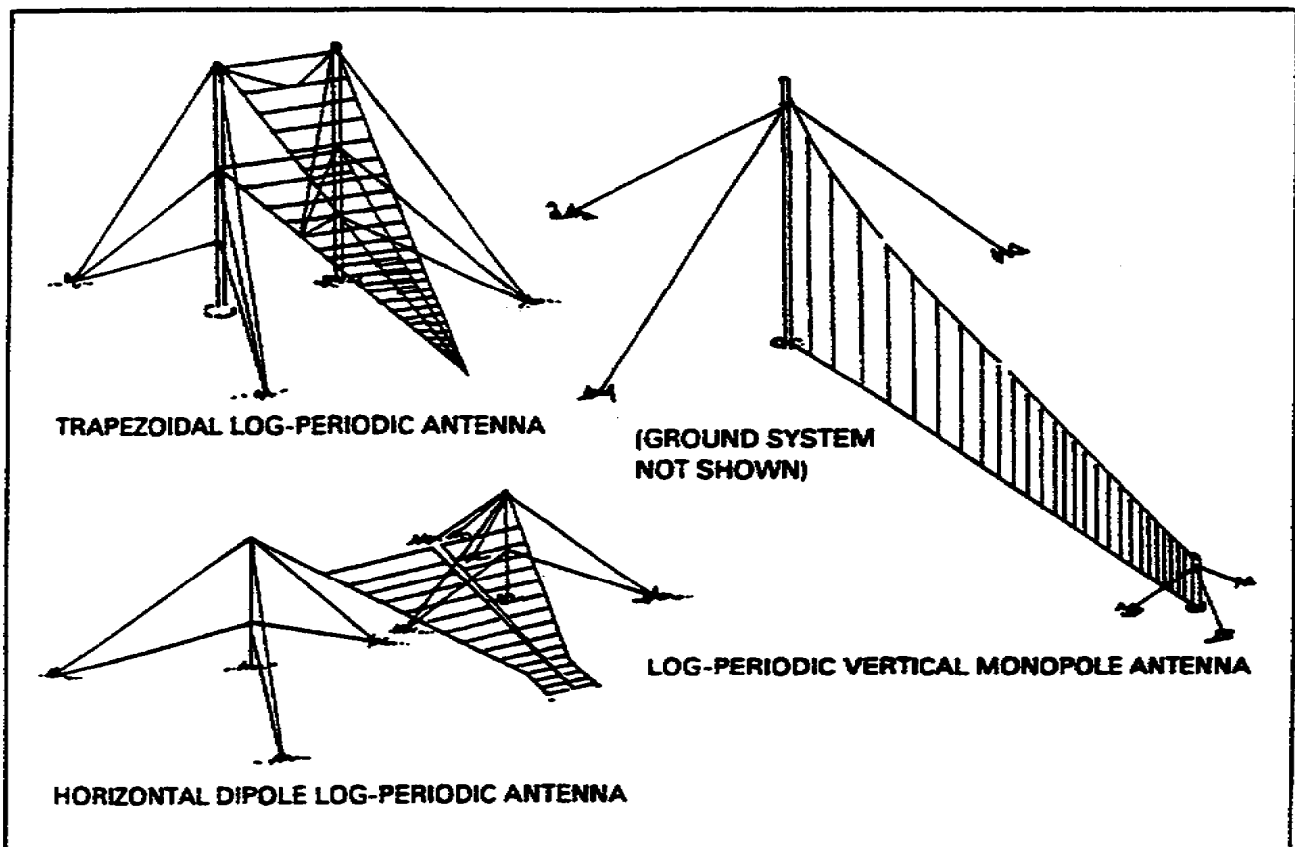

Figure 2-8. Log-periodic antenna

b. This high-gain, lightweight, directional antenna is capable of operating in the 30-to 88-MHz frequency range without having to be physically tuned by the operator. Its highly directional pattern makes it especially suited in providing point-to-point communications. It is oriented in the direction of the desired transmission by using a compass and the appropriate map sheet.

c. The OE-303 antenna is rugged enough to withstand moving (erection and teardown) every four to six hours. It can operate in harsh climatic conditions. It can be erected by two soldiers in 20 minutes or less in a geographical area 175 ft in diameter or less, depending on the frequency used. This antenna can be mounted on any structure about 50 feet in height, and is capable of azimuth directional change within one minute. Mast assembly AB-1244 is the primary antenna support structure used with the half-rhombic VHF antenna. Using its mast assembly, this antenna is 30 feet high.

d. The antenna and all the ancillary equipment (guys, stakes, tools, mast sections) are contained in two carrying bags for manpack or vehicular transportation. Figure 2-9 depicts the half-rhombic antenna.

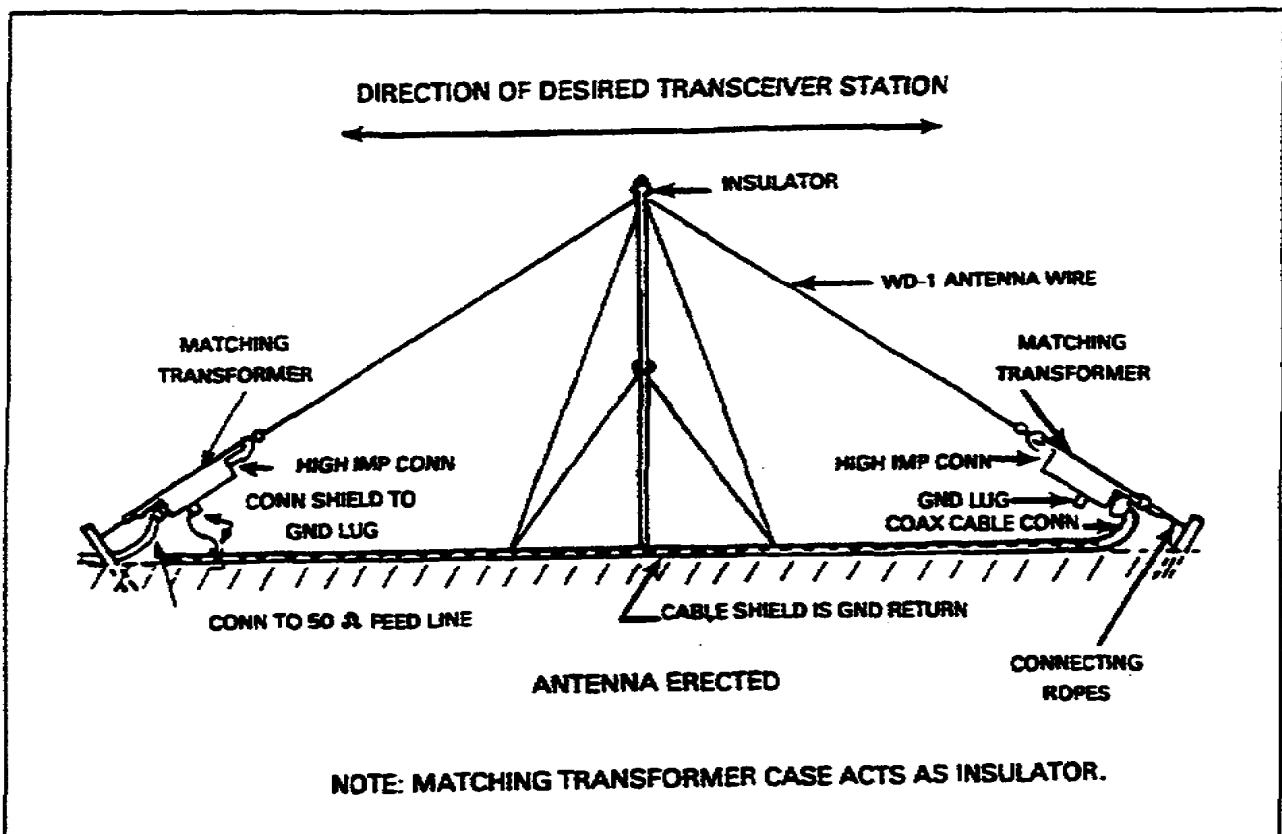

Figure 2-9. Half-rhombic VHF antenna

7. Near vertical incidence sky wave (NVIS). NVIS antenna AS-2259/GR is a lightweight sloping dipole, omnidirectional antenna used with AM radios (AN/GRC-106) and improved high frequency radios (IHFR)(AN/PRC-104A and AN/GRC-213/193A) that operate in the HF range of 2 to 30 MHz. Like the doublet antenna, the NVIS is used when the tactical situation allows stationary operations. The NVIS extends radio range up to 300 miles by using sky wave propagation. Polarized horizontally and vertically at the same time, it can be erected by two soldiers in about five minutes. Figure 2-10, page 2-10, shows an operator using an NVIS antenna with an AN/PRC-104A portable radio.

8. Combat net radio (CNR). CNR is designed around three separate radio systems--IHFR, Single-Channel Ground and Airborne Radio System (SINCGARS), and single-channel tactical satellite (TACSAT) radios.

a. The IHFR is replacing the older HF manpack (AN/PRC-70/74) and vehicular (AN/GRC-106) radios. User-owned and operated, it employs both ground and sky wave propagation for short and medium-range communications to pass voice and data signals. The IHFR uses the manpacked whip antenna, the vehicle-mounted whip antenna, the AN/GRA-50 doublet antenna, and the AS-2259 NVIS antenna.

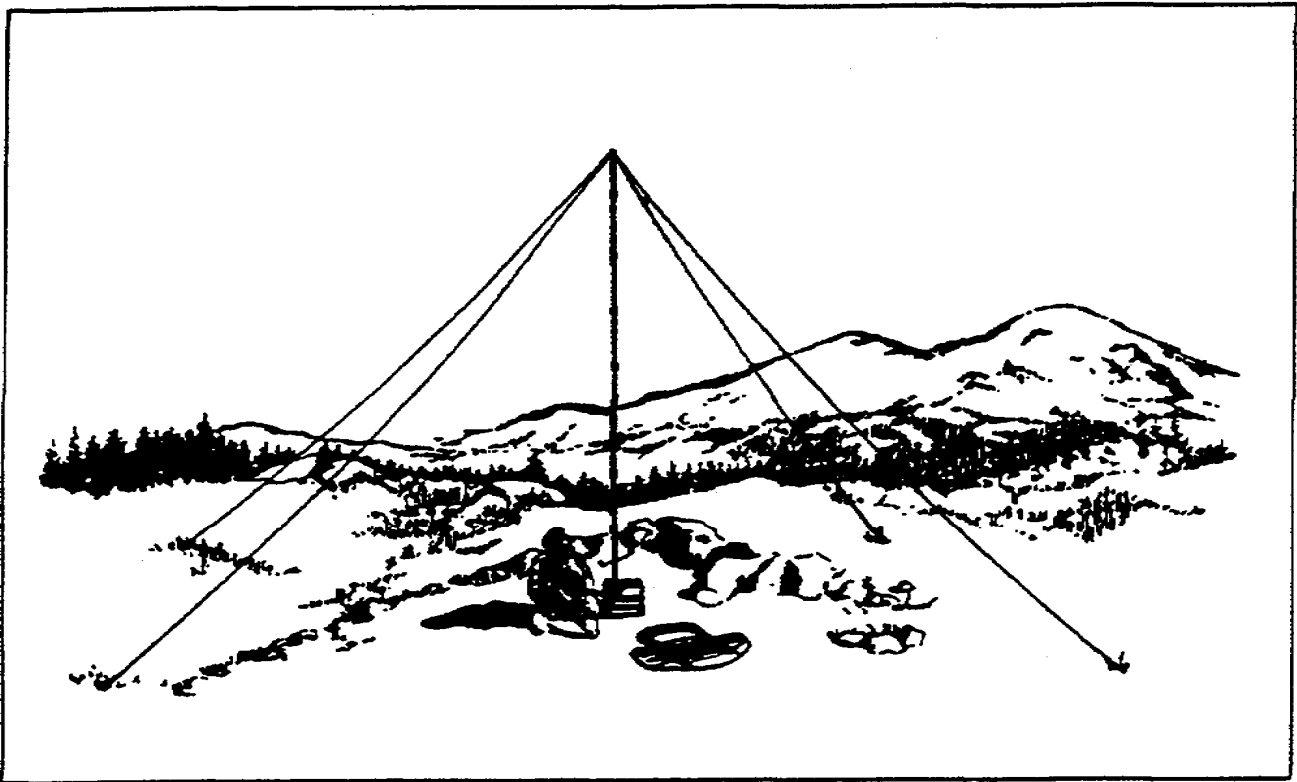

Figure 2-10. NVIS antenna

(1) The AT-271A/PRC, one type of collapsible whip antenna for manpack operation, is depicted in Figure 2-11. This antenna is easily assembled and broken down. The cord running through the sections provides the tension needed to keep them together.

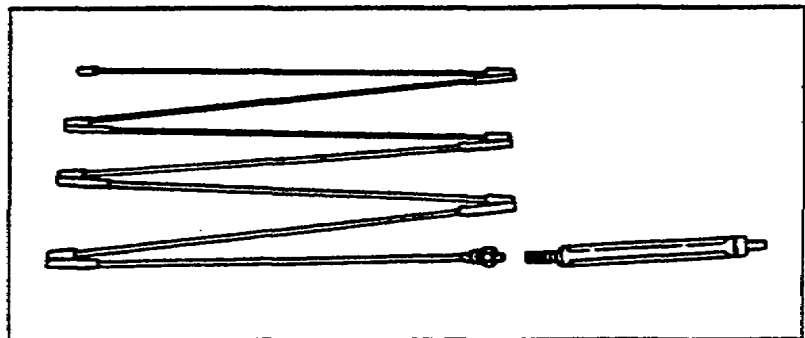

Figure 2-11. Collapsible whip antenna AT-271 A/PRCC with antenna base

(2) The AS-3683/PRC, another whip antenna used with the AN/PRC-104A and the SINCGARS radios, is shown in Figure 2-12. This is a very flexible antenna especially suited for use in thick brush or jungle. Its flexible goose-neck antenna base allows the operator to orient it to obtain optimum reception. However, using the goose neck antenna base is optional.

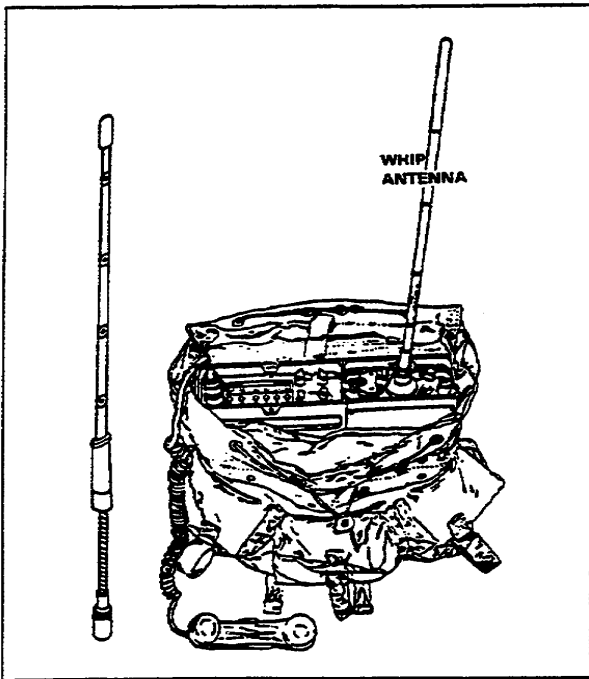

Figure 2-12. Flexible whip antenna AS-3683/PRC

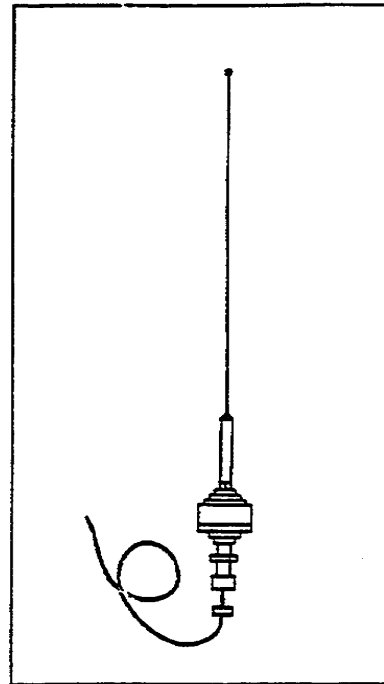

Figure 2-13. Vehicle-mounted whip antenna

(3) A whip antenna used with the AN/GRC-213 in a vehicle-mounted configuration is shown in Fig 2-13. When installed with the vehicle installation kit, this antenna is the most convenient to use because it allows communications while the vehicle is moving and it has a omnidirectional (360°) radiation pattern. It also requires no support except for the vehicle mount. A disadvantage is that its propagation range is shorter than either the doublet or NVIS antennas.

b. SINCGARS operates in the VHF range.

(1) SINCGARS uses broadband antennas that do not have to be changed when frequencies are changed, such as the OE-254 ground-plane and the AS-3900 and AS-3684 vehicular whip antennas. The output frequency can change in a wide range between hops due to the frequency hopping nature of SINCGARS. The narrow band RC-292 ground-plane antenna cannot be used.

(2) Like the IHFR, SINCGARS uses the manpack whip antenna (AS-3683/PRC) for communicating in heavy vegetation or when the transmitting range is deliberately limited. It also operates using the AS-3684/VRC whip antenna, a 10-foot long antenna that consists of two antenna elements and a matching unit base (Figure 2-14). The base spring allows the antenna to bend when it strikes an obstruction

c. TACSAT operates in the UHF range. The AN/PSC-3 and AN/VSC-7 communications systems are lightweight, highly compact, and deployable in quick-reaction situations where extended communication range is essential to mission effectiveness. They can operate on-the-move/line-of-sight (LOS) at 2 watts or in the at-halt/satellite mode at 35 watts. They can transmit or receive in voice or data formats in both modes. Figure 2-15 shows the AN/PSC-3 radio set. This medium gain, collapsible parabolic antenna can be set up in minutes and is highly reliable. The AN/VSC-7 TACSAT radio set (Figure 2-16) used as a net control station and is mounted in a tactical truck or an S-280 communications shelter. It can serve up to 15 AN/PSC-3 terminals in a communications net with the selection of conference or individual call-codes. Its low-gain omnidirectional whip antenna provides LOS. The AN/VSC-7's high-gain antenna enhances transmission and reception.

9. UHF antennas. These highly directional antennas are used with mobile subscriber equipment (MSE) and the older multichannel systems. They concentrate radiation in a given direction and minimize radiation in other directions. Their high directivity also aids in obtaining a slight degree of transmission security, making enemy direction finding more difficult, and reducing noise and interference.

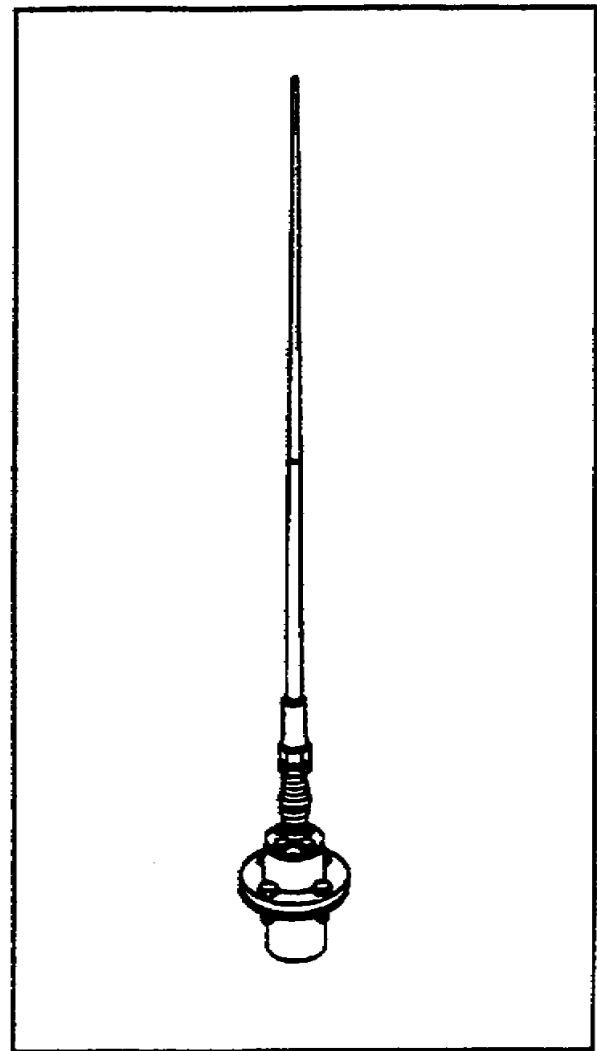

Figure 2-14. AS-3684/VRC vehicular antenna

a. The corner-reflector (flyswatter) antenna consists of an adjustable reflector and an antenna element. It is used in multichannel systems with radios that operate in the 200-to 1000-MHz range. Highly directional, its reflector angle can be adjusted to operate on any frequency within its range. This antenna is usually used with radio sets that have RF duplexing capabilities. The RF duplexer permits the radio set to transmit and receive, using one coaxial cable between the antenna and the radio set. The corner-reflector is shown in both vertical and horizontal polarization positions in Figure 2-17, page 2-14.

b. The horn-type antenna is a directional antenna with a modified dipole element mounted in a ridge-loaded horn. The horn-type antenna used in multichannel systems are pyramidal (rectangular and flared in both planes). The horn is designed to get the flare, length, and aperture that will give the best performance throughout the horn's entire frequency range. This combination of flare, length, and aperture emits a narrow beam of high-intensity RF energy in the forward direction. Horn antennas can be vertically or horizontally polarized, and can be mounted in pairs on the same mast or singularly on separate masts. When used with a radio set having an RF duplex, a single horn can be used to transmit and receive radio signals. Horn-type antennas are used with some radio sets that operate on frequencies from 601.5 to 1849.5 MHz. The horn antenna is broadband and no adjustments are made when changing frequencies. Elevation or depression angles may be made at the antenna's rear, as needed. A rear view of a pair of horn-type antennas mounted in a vertical polarization is shown in Figure 2-18, page 2-14.

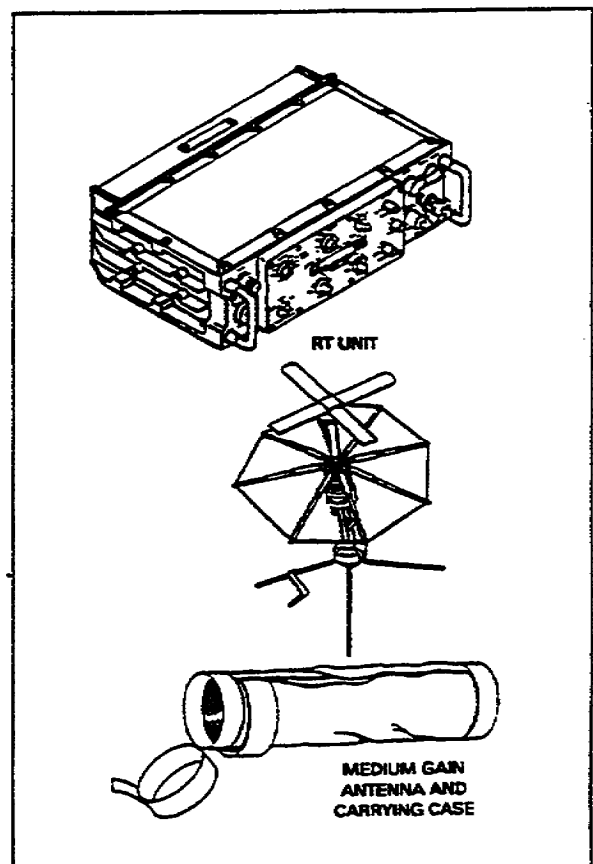

Figure 2-15. AN/PSC-3 TACSAT radio set

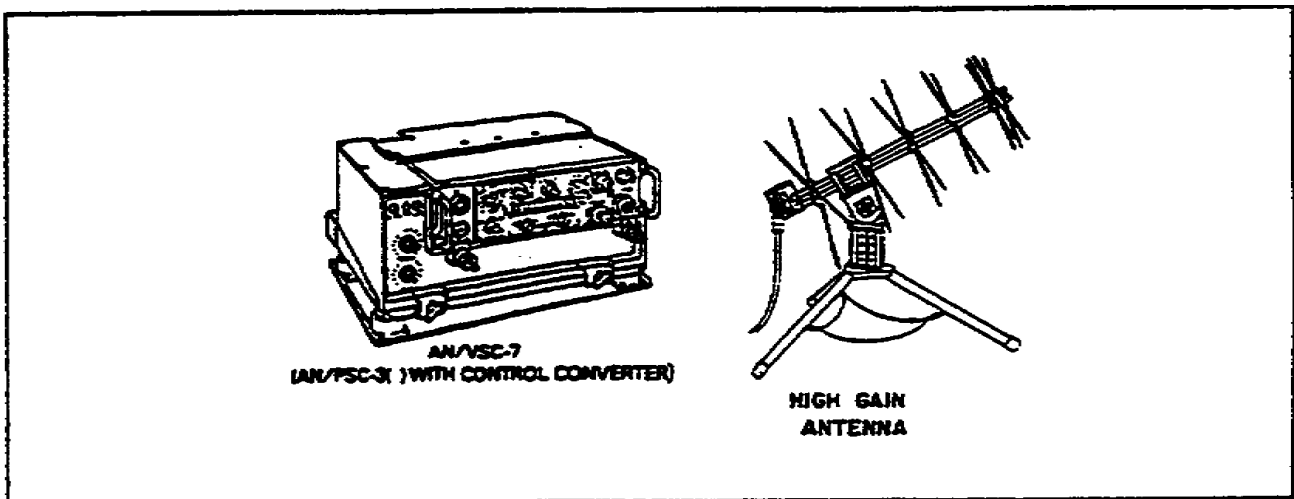

Figure 2-16. AN/VSC-7 TACSAT radio set

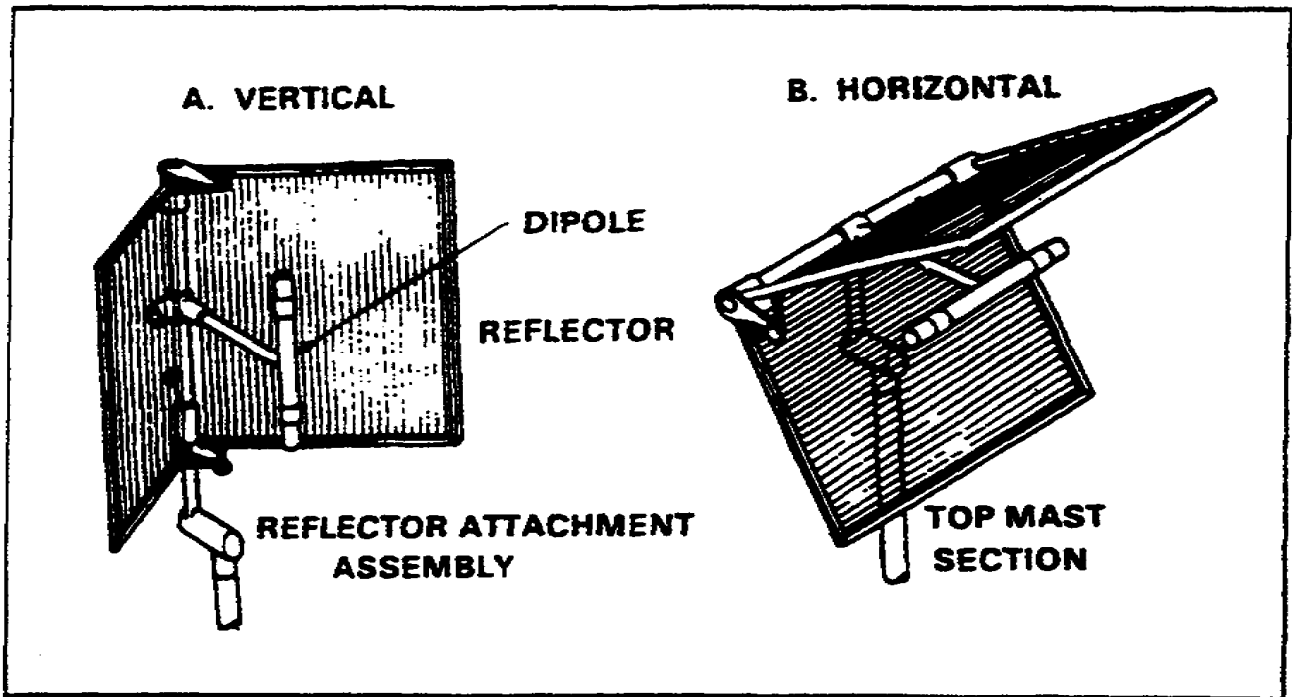

Figure 2-17. Typical corner reflector antenna

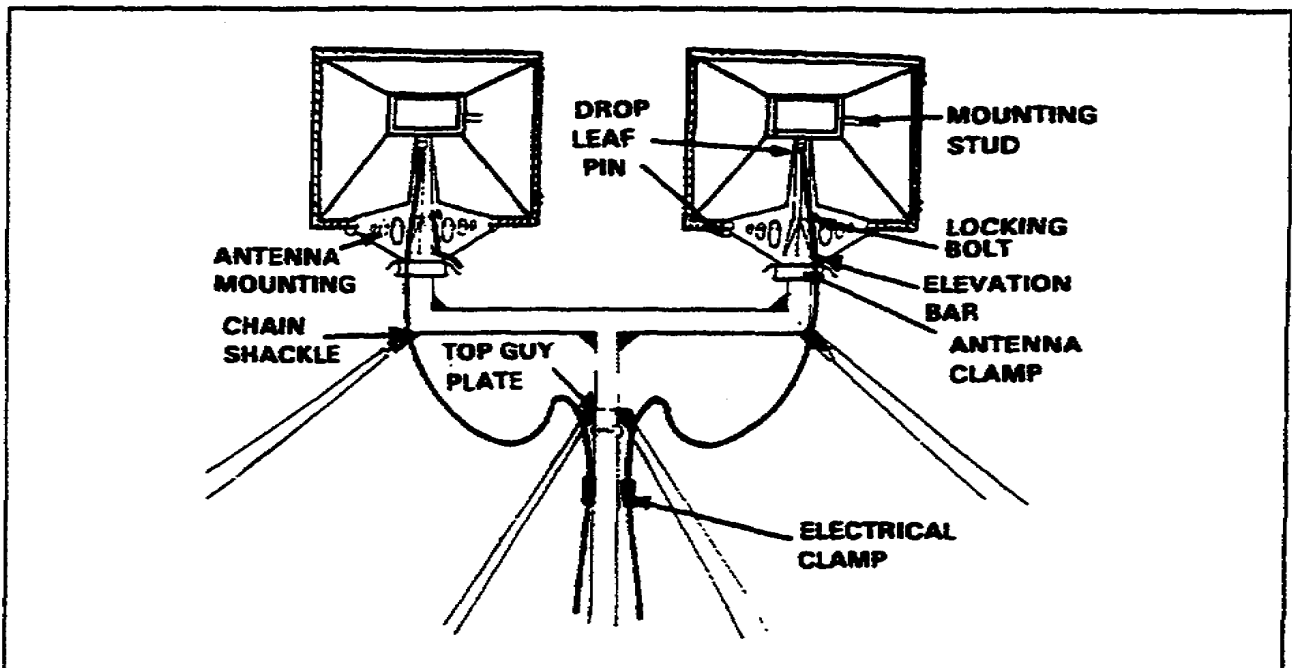

Figure 2-18. Typical horn-type antenna

c. The parabolic reflector antenna consists of a saucer-like reflecting surface (parabola) and a dipole (feed device) placed at its focal point. There are numerous types of reflector antennas used, depending on the frequency. The MSE LOS radios use parabolic reflector antennas mounted on 15-meter masts. Figure 2-19 shows two examples of parabolic antennas.

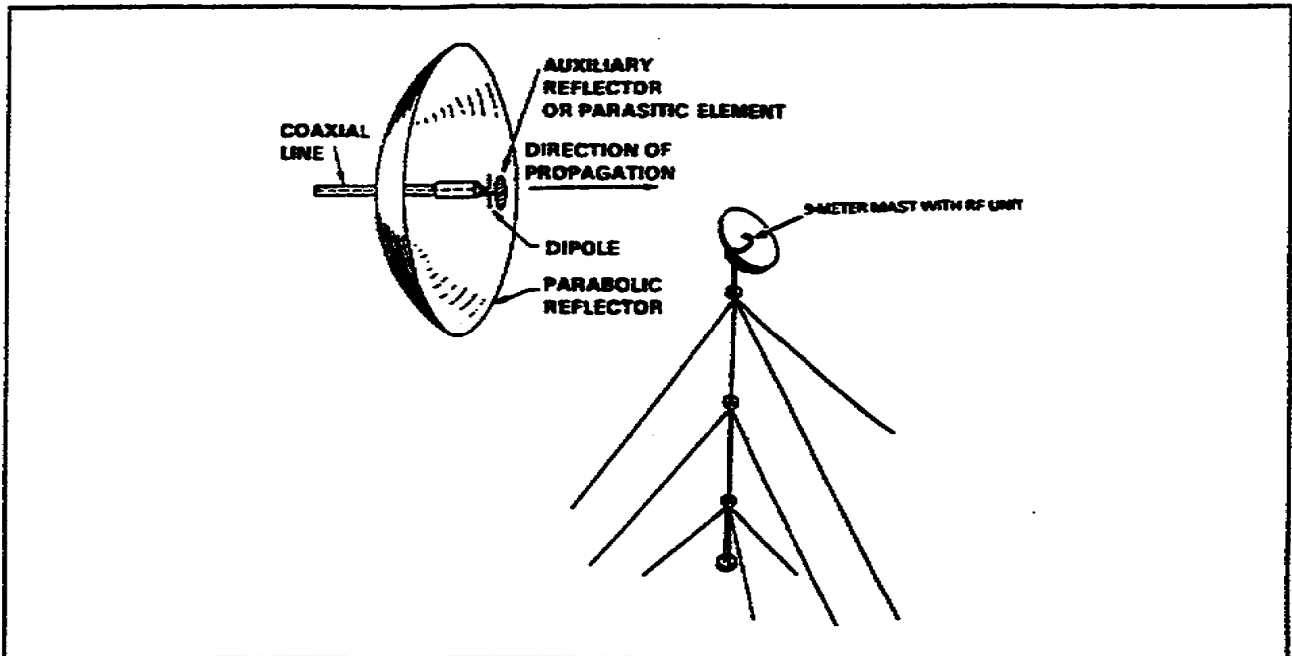

Figure 2-19. Parabolic reflector antennas

10. Field repair and expedients. Antennas are sometimes broken or damaged, resulting in failed or poor communications. In the days before cable television, viewers at home received a TV signal through an antenna, either strapped to the chimney or sitting on top of the set. If the antenna was missing or broken, an expedient loop antenna could be fashioned from a simple coat hanger. Reception was not the best, but it was tolerable. Remember, as a signal officer, your job is to get the message through. Knowing how to do a field expedient repair job may come in handy some day. The following antenna repair techniques have been proven to work.

a. Metallic whip antennas.

(1) Should a whip antenna break into two sections, you can lash the two sections together to provide a good mechanical connection. To ensure essential electrical

conductivity, scrape the paint off of each section's end and tie them together with stripped field wire (WD-1). Solder the connection if you have the time and equipment. Place a stick, pole, or branch on each side of the break and wrap the splint tightly with field wire, rope, or tape, as shown in Figure 2-20.

(2) If you lose your antenna and are left with just a stub, you can use another repair method to get back on the air. If the missing section is about 6 feet long, just find a pole the same length and lash it to the stub. Scrape off the paint from the top 2 inches of the whip's stub and wrap about 12 inches of bare wire around the stub's scraped portion. Wrap it tight and tape it securely. Attach a length of WD-1 along the pole's length with tape. The total length of the upright WD-1 and antenna stub should be the same length as the length of the original antenna. This antenna will not take much abuse, but it will send and receive signals. Figure 2-21 illustrates this technique.

b. Vertical antennas transmit and receive omnidirectionally. Most tactical antennas used for vehicular and manpack radios are vertical. A vertical antenna can be improvised by using a metal pipe or rod of the correct length, held erect by guy lines. The antenna's lower end is insulated from ground by placing it on insulating material. Figure 2-22 shows vertical antennas made of wire and supported by a tree and a wooden pole. If the vertical mast is not long enough to support the wire upright, the connection can be modified at the antenna's top, as shown in Figure 2-23.

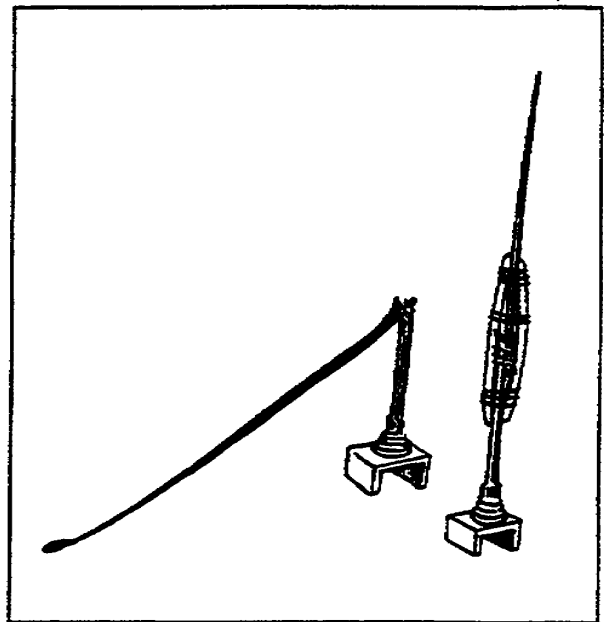

Figure 2-20. Spliced metallic whip antenna

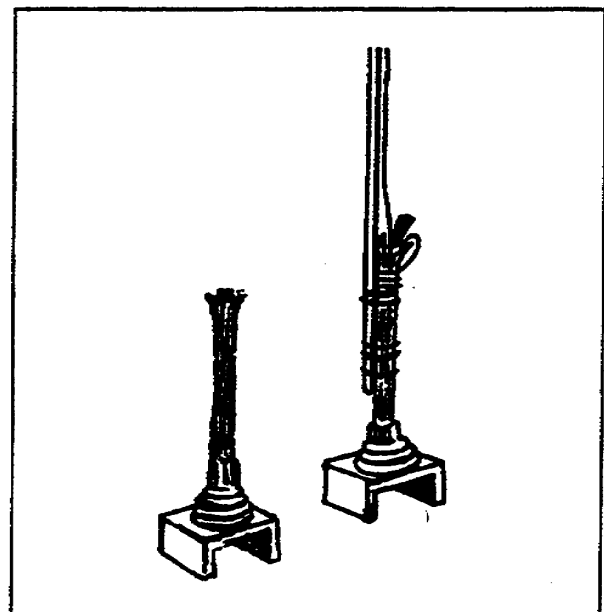

Figure 2-21. Spliced metallic whip antenna using WD-1 as part of the antenna

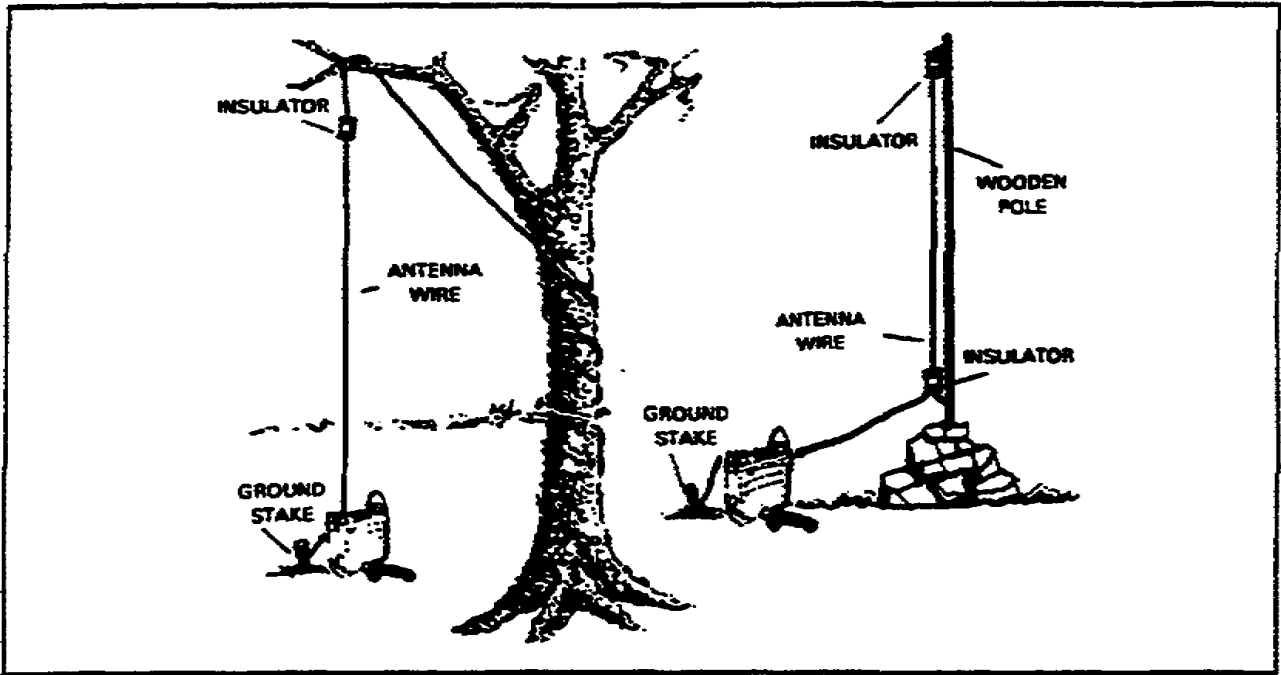

Figure 2-22. Field substitutes for support of vertical wire antennas

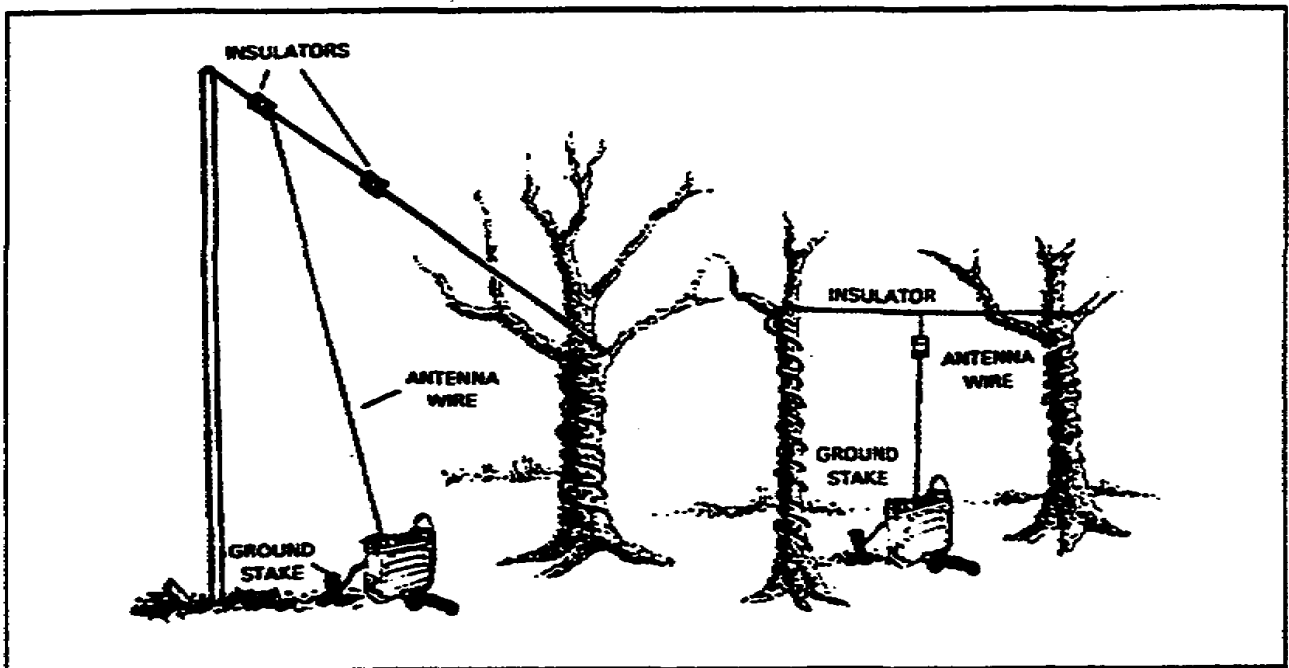

Figure 2-23. Additional means of supporting vertical wire antennas

c. The electrical length of an end-fed, half-wave antenna is measured from the antenna terminal on the radio set to the antenna's far end. For optimum performance, the antenna should be constructed longer than necessary, and shortened as required until the best results are achieved. The ground terminal of the radio set should be connected to a good Earth ground for this antenna to operate efficiently. This antenna is depicted in Figure 2-24.

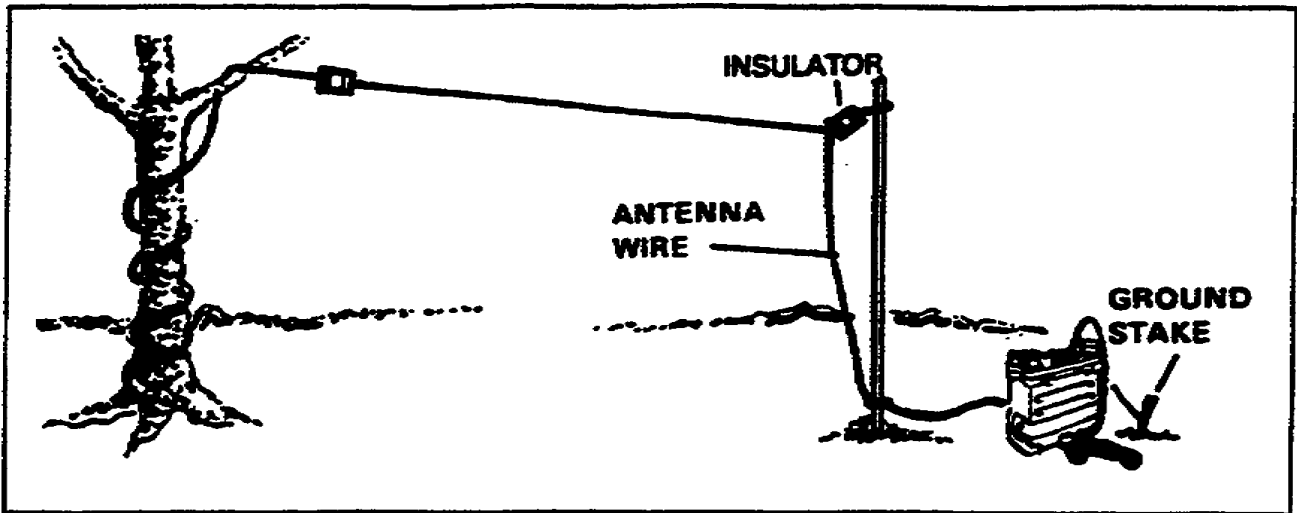

Figure 2-24. End-fed half-wave antenna

d. The center-fed doublet antenna is a half-wave antenna consisting of two quarter-wavelength sections on each side of the center (Figure 2-25). Doublet antennas are directional broadside to their length; this makes the vertical doublet antenna essentially omnidirectional. The horizontal doublet antenna is bidirectional. A center-fed half-wave FM antenna can be supported by a wooden frame, shown in Figure 2-26. View A shows a horizontal antenna, and view B shows a vertical antenna. These antennas can be rotated to any position to obtain the best performance. If the antenna is erected vertically, the transmission line should be brought out horizontally from the antenna for a distance equal to at least one-half of the antenna's length before it is dropped down to the radio set.

e. Two field-expedient directional antennas are the vertical half-rhombic antenna (Figure 2-27, page 2-20) and the long-wire antenna (Figure 2-28, page 2-20). These antennas consist of a single wire, preferably two or more wavelengths long, supported on poles at a height of 3 to 7 meters (10 to 20 feet) above the ground. If needed, the antennas will operate satisfactorily as low as 1 meter (about 3 feet) above the ground. The wire's far end is connected to ground through a noninductive 500-to 600-ohm resistor. To ensure that the transmitter's output power will not burn out the resistor, a resistor rated at least one-half of the transmitter's wattage output should be used. A reasonably good ground, such as a number of ground rods or a counterpoise, should be used at both ends of the antenna. The radiation pattern is directional. These antennas are used primarily for transmitting or receiving HF signals.

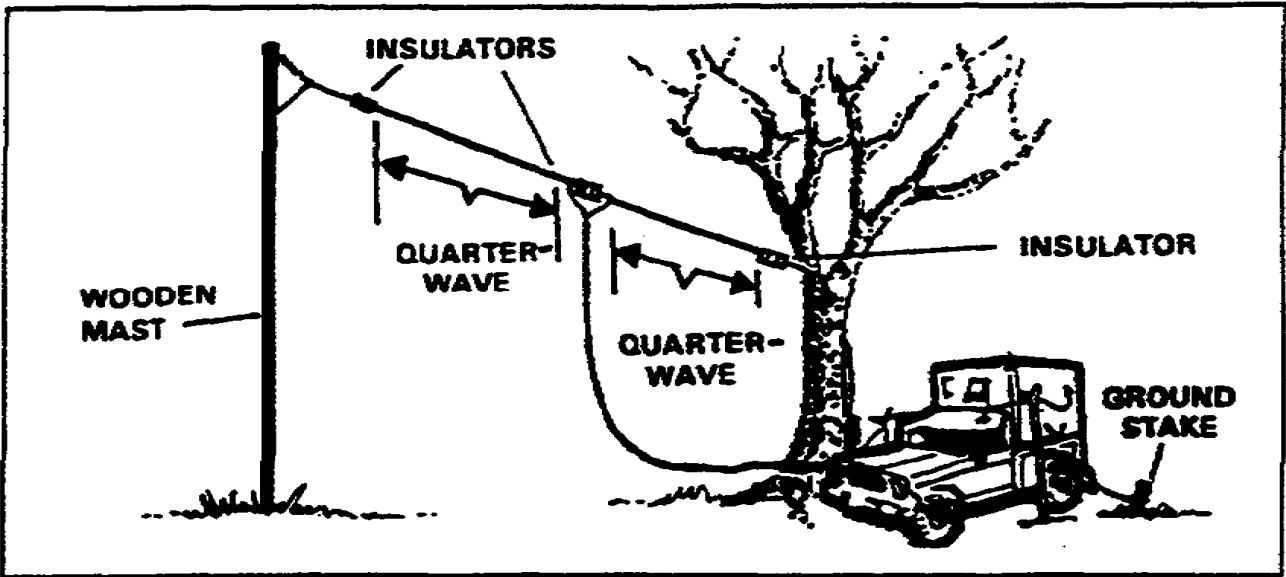

Figure 2-25. Half-wave doublet antenna

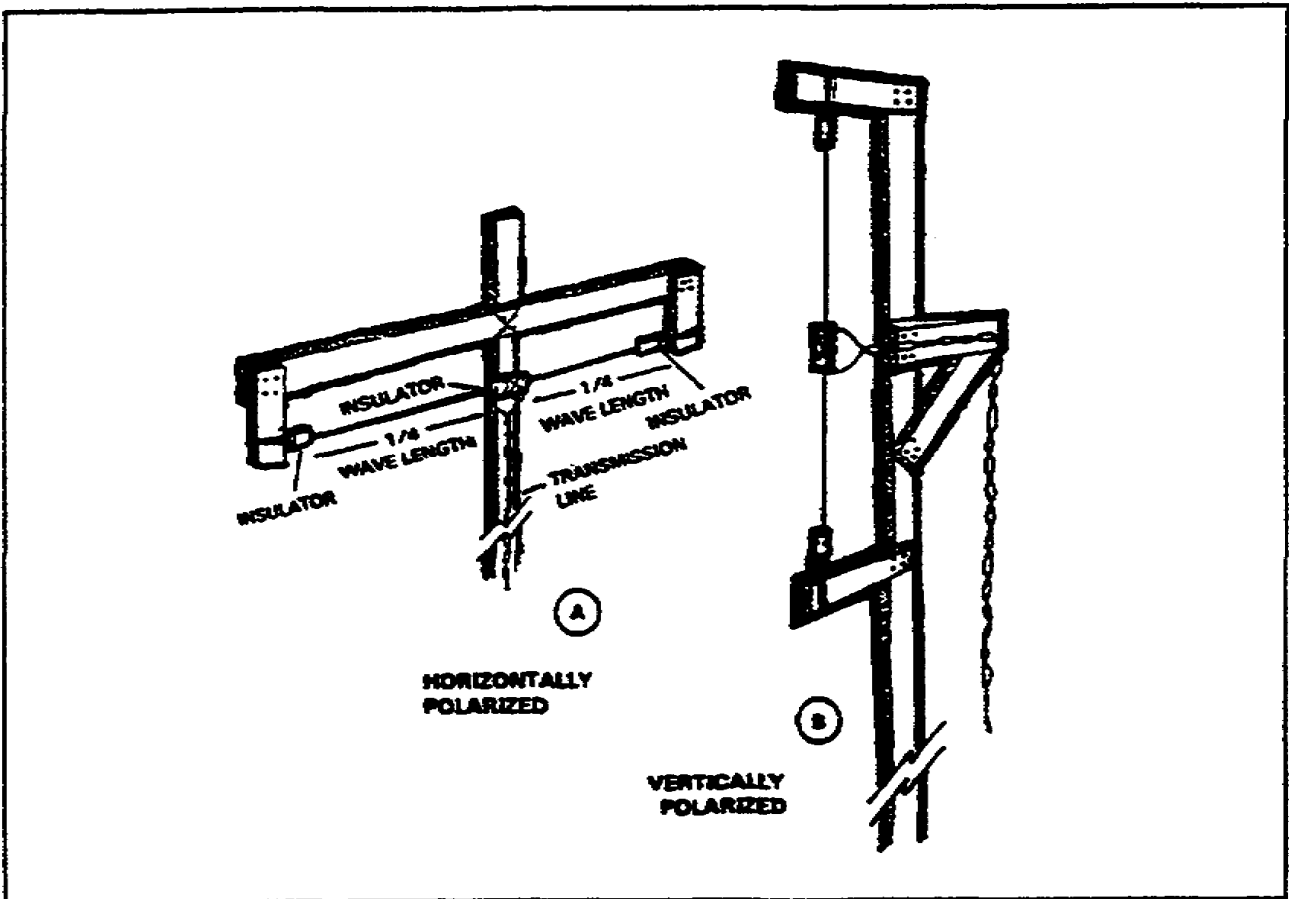

Figure 2-26. Center-fed half-wave antenna

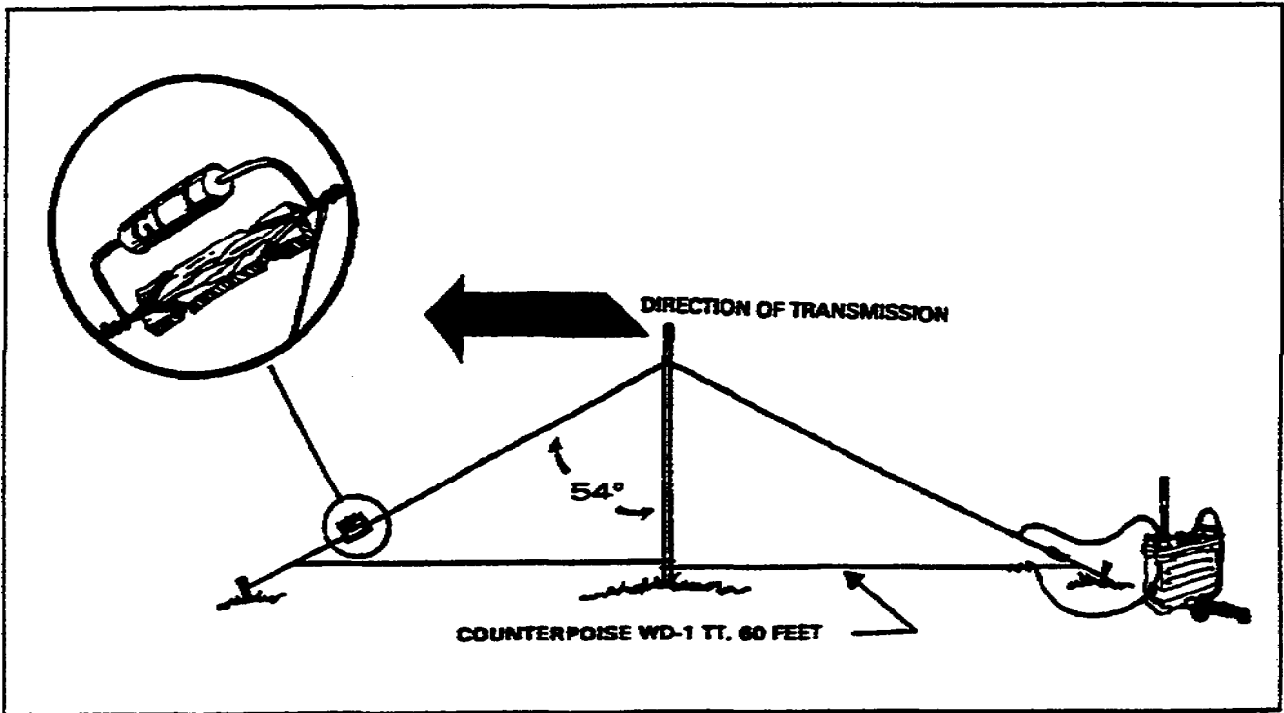

Figure 2-27. Vertical half-rhombic antenna

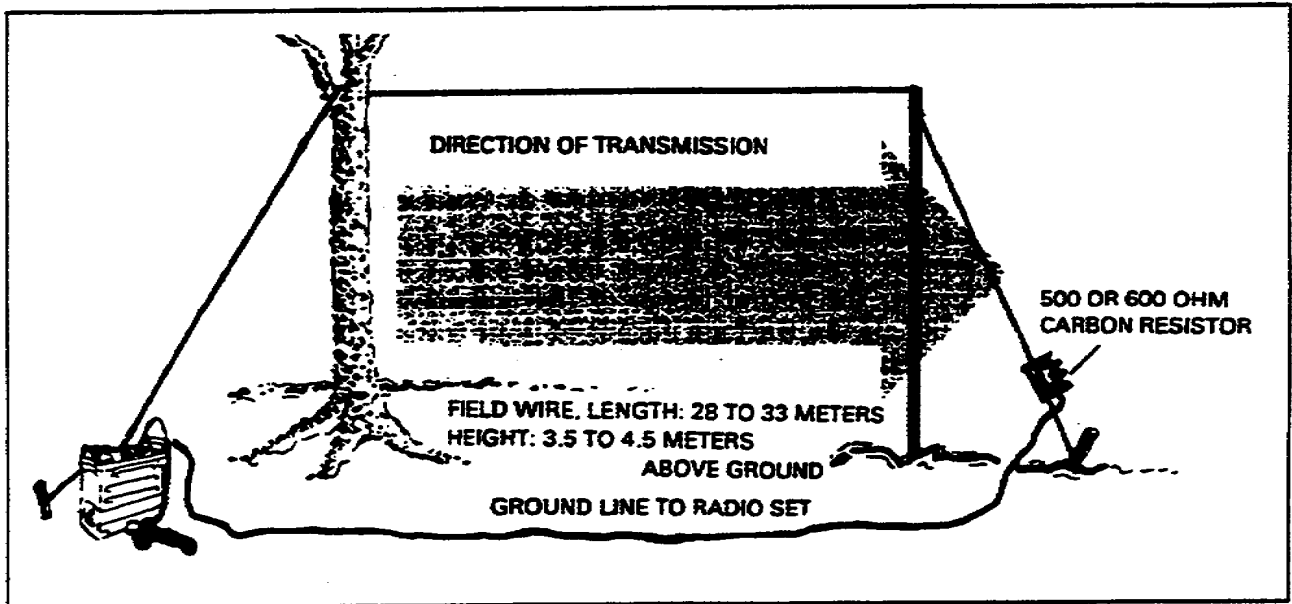

Figure 2-28. Long-wire antenna

f. The V antenna

(1) This antenna consists of two wires forming a V, with the open area of the V pointing toward the desired direction of transmission or reception (Figure 2-29). An easier way of constructing this antenna is to slope the legs downward from the apex of the V; this is called a sloping-V antenna (Figure 2-30).

(2) The angle between the legs varies with the length of the legs in order to achieve minimum performance. Table 2-1, page 2-22, can be used to determine the angle and the length of the legs.

(3) When this antenna is used with more than one frequency or wavelength, an apex angle is used that is midway between the extreme angles determined by the chart.

(4) To make the V antenna radiate in only one direction, noninductive terminating resistors are added from the end of each leg (not at the apex) to ground. The resistors should be approximately 500 ohms and have a power rating at least half that of the output power of the transmitter being used. The antenna will radiate bidirectionally, both front and back without the resistors.

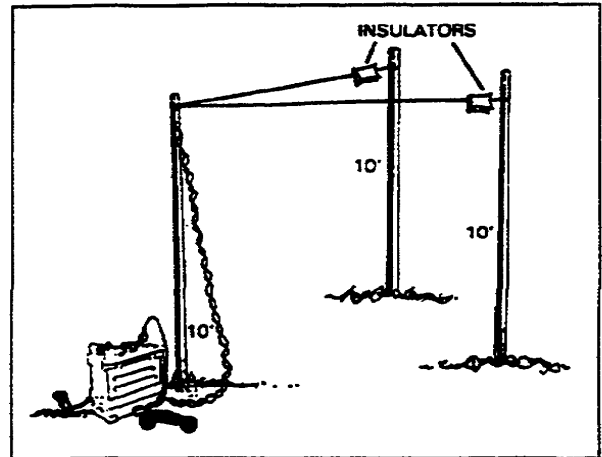

Figure 2-29. V antenna

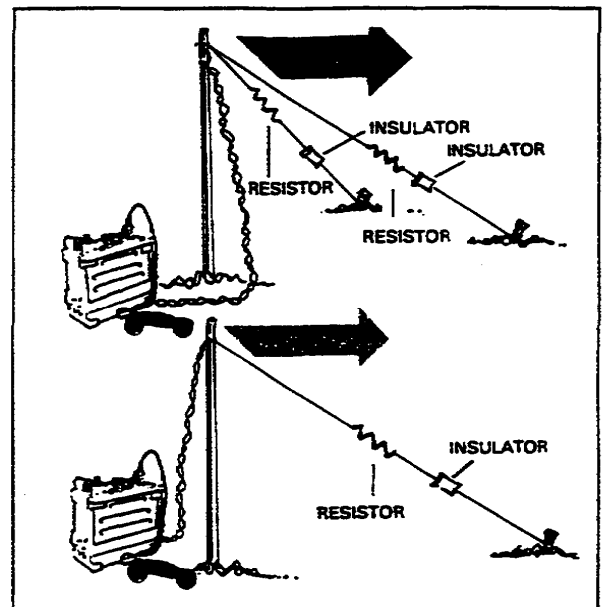

Figure 2-30. Sloping-V antenna

Table 2-1. Leg angle for V antennas

ANTENNA LENGTH (wavelength)	OPTIMUM APEX ANGLE (degrees)
1	90
2	70
3	58
4	50
6	40
8	35
10	33

11. Safety. Soldiers are still occasionally killed or seriously injured a result of antenna accident, in spite of repeated safety warnings tough briefings, publications, and messages. As a signal officer, you should develop a keen sense of field safety, especially as it relates to signal operations. If you know an antenna is too close to a power line, insist that it be dropped and moved. Safety tips and warnings that are found in many signal-related publications are shown in Figures 2-31 and 2-32, pages 2-24 and 2-25, respectively. Study these safety tips and warnings and think back to experiences you have had during previous operations. Have you violated any of these warnings? If the answer is no, you are to be commended for your good approach to safety. If the answer is yes, then resolve to heed the warnings henceforth.

12. Summary. In this lesson, you learned about the types of tactical antennas, their radiation patterns, and how to fabricate field-expedient antennas using various repair techniques.

a. The half-wave antenna is also called a doublet, a dipole, or a Hertz antenna. It is center-fed. Its total wire length is one half of the wavelength of the signal to be transmitted.

b. The whip antenna provides an omnidirectional radiation pattern. It is a quarter-wave antenna used for manpack and vehicular operations.

c. The ground-plane antenna is a vertical quarter-wave antenna that increases the range of tactical FM radio sets. Its radial elements provide a counterpoise that simulates a ground. The older RC-292 has radial elements that must be changed accordingly with frequency changes. The OE-254 does not require any changes in elements when frequencies change.

d. The log-periodic antenna is very directional and is usually used in point-to-point communications.

e. The half-rhombic antenna OE-303 provides an extended range and affords some ECCM protection (not omnidirectional).

f. The NVIS is a sloping dipole that gives an omnidirectional pattern for AM radios. It can extend the range up to 300 miles.

g. The two CNR antennas are the AT-271A/PRC, a collapsible whip for manpack operations, and the AS-3683/PRC, a flexible antenna used in areas of heavy vegetation.

h. The three SINCGARS antennas are the OE-254, the AS-3684/VRC (vehicular mounted), and the AS-3683/PRC.

i. The two TACSAT antennas are the collapsible parabolic reflector for the AN/PSC-3 and the omnidirectional whip antenna for the AN/VSC-7.

j. There are several UHF antennas.

(1) The corner-reflector (flyswatter) antenna is highly directional and is used with multichannel systems.

(2) The horn-type antenna is another antenna used in multichannel systems. The flared design serves to direct the RF energy in a highly directional pattern.

(3) The parabolic reflector antenna has a reflecting surface and a dipole at its center. The reflector is used to capture or release signals.

k. There are several field expedient antennas.

(1) Metallic whip. Broken whips can be lashed together using WD-1, rope, and tape. If part of the antennas is missing, field wire can be used as the radiating element.

(2) Directional antennas. The vertical half-rhombic and the long-wire antennas are used for transmitting and receiving HF signals.

(3) V antenna. It is made of two wires forming a V with the open end pointing toward the direction of transmission. Using a resistor changes the V antenna from bidirectional to unidirectional.

Never erect long-range antennas directly under power lines.

If you must erect long-range antennas near power lines, power line poles or towers, or buildings with overhead power line connections, never put the antenna closer than two times the antenna height from the base of the power line, pole, tower, or buildings (100 feet away is a good safe round number to remember).

Never attempt to erect any long-range antenna without a full team.

Before erecting a long-range antenna, inspect all the parts making up the antenna kit. Do not erect the antenna if any parts are missing or damaged.

Do as much of the assembly work as possible on the ground.

When erecting an antenna, allow only team personnel in the erection area.

Make sure that the area for the anchors is firm. If the ground is marshy or sandy, get specific instructions from your crew chief or supervisor on how to reinforce the anchors.

When selecting locations for anchors, avoid traveled areas and roads. If you cannot avoid these areas, get specific instructions from your supervisor as to what clearance your guy wires and ropes must have over the traveled areas and road.

Clearly mark all guy wires and ropes with the warning flags or signs supplied by your unit. In an emergency, use strips of white cloth as warning streamers.

If you suspect that power lines have made accidental contact with your antenna, stop operating, rope off the antenna area, and notify your superiors.

If the weather in your area can cause ice to form on your long-range antenna and its guy wires and ropes, add extra guys to support the system. Rope off the area and post it with warning signs like "Beware of Falling Ice."

Do not try to erect an antenna during an electrical storm.

Keep a sharp eye on your anchors and guys. Check them daily and immediately before and after bad weather.

Figure 2-31. Safety tips

WARNING

Serious injury or even death can happen if the following are not carefully observed when installing and using the antennas used with your radio sets.

Before any mission, find out—

- Are there any power lines in your area of operation?
- How high are these power lines?
- How tall are the poles or towers carrying power lines?

MOBILE OPERATION WITH WHIP ANTENNAS

Do not stop your vehicle under power lines.

- If possible, try to maintain mobile communications with your antenna(s) tied down.
- Make sure an antenna tip cap is securely taped on the end of each whip antenna.
- Do not lean against or touch a whip antenna while the transmitter is on.
- *During cross-country operation, do not allow anyone to stick an arm, leg, or weapon over the sides of the vehicle. If your antenna accidentally touches a power line and a leg, arm, or weapon contacts a damp bush or the ground, a serious or fatal accident can happen.*
- If you are not sure that an antenna on your vehicle will clear a power line, stop before you get close to the power line and either carefully tie down the antenna or remove antenna sections to make sure that you can safely drive under the power line.

Figure 2-32. Safety warning

LESSON 2

PRACTICE EXERCISE

The following items will test your grasp of the material covered in this lesson. There is only one correct answer for each item. When you complete the exercise, check your answer with the answer key that follows. If you answer any item incorrectly, study again that part of the lesson which contains the portion involved.

1. Which statement describes the half-wave antenna?
 - A. It is used at lower frequencies
 - B. It cannot be used on a vehicle
 - C. Unlike the quarter-wave antenna, it is not center fed
 - D. It can extend the signal range to 300 miles and beyond using sky wave propagation

2. What should be the height of the vertical radiator of a whip antenna?
 - A. A quarter wavelength
 - B. A half wavelength
 - C. A full wavelength
 - D. Two wavelengths

3. The RC-292 and OE-254 are what type of antennas?
 - A. Directional VHF
 - B. Bidirectional VHF
 - C. Omnidirectional FM
 - D. Omnidirectional AM

4. Which statement describes the unidirectional log-periodic antenna?
 - A. It operates in the 30- to 90-MHz frequency range
 - B. Its radiation pattern provides very effective electronic countermeasures
 - C. It provides an extended range for tactical radios
 - D. Its radiated energy is not focused in one direction

5. The NVIS antenna uses what type of polarization?
 - A. Vertical only
 - B. Elliptical and horizontal
 - C. Elliptical and vertical
 - D. Horizontal and vertical

6. Which characteristic describes the antenna matching unit?
- A. Changes the modulation from AM to FM
 - B. Matches the frequency to the radiation pattern
 - C. Varies the electrical length of the antenna to accommodate a range of frequencies
 - D. Varies the electrical length of the antenna to accommodate a change in radiation pattern
7. Which statement describes antenna use by SINCGARS?
- A. The RC-292 can extend the range of the SINCGARS systems up to 36 miles
 - B. SINCGARS uses broadband antennas
 - C. SINCGARS cannot use the AS-3683/PRC antenna
 - D. SINCGARS antennas have to be changed with changing frequencies
8. The AN/PSC-3 TACSAT system can transmit up to how many watts in the at-halt mode?
- A. 2
 - B. 3
 - C. 20
 - D. 35
9. Which statement describes the horn-type antenna?
- A. It must be adjusted each time the frequencies are changed
 - B. It is a directional antenna
 - C. It can only be horizontally polarized
 - D. Elevation angles may be made at its front, as needed
10. Which statement describes antenna use?
- A. A vertical half-rhombic antenna does not have a directional radiation pattern
 - B. A long-wire antenna has a directional radiation pattern
 - C. A vertical half-rhombic antenna can operate as low as 2 feet above the ground
 - D. A long-wire antenna is used primarily for transmitting EHF signals

LESSON 2

PRACTICE EXERCISE

ANSWER KEY AND FEEDBACK

<u>Item</u>	<u>Correct Answer and Feedback</u>
1.	D. It can extend the signal range to 300 miles and beyond using sky wave propagation (page 2-2, para 2)
2.	A. A quarter wavelength (page 2-3, para 3)
3.	C. Omnidirectional FM (page 2-4, para 4)
4.	C. It provides an extended range for tactical radios (page 2-6, para 5a)
5.	D. Horizontal and vertical (page 2-7, para 6)
6.	C. Varies the electrical length of the antenna to accommodate a range of frequencies (page 2-3, para 3b)
7.	B. SINCGARS uses broadband antennas (page 2-11, para 8b(1))
8.	D. 35 (page 2-12, para 8c)
9.	B. It is a directional antenna (page 2-13, para 9b)
10.	B. A long-wire antenna has a directional radiation pattern (page 2-18, para 10e)